



Haas Factory Outlet
A Division of Productivity Inc



Haas Lathe Operator

Revised 8/2022 JP



This Manual is the Property of Productivity Inc.

It may not be reproduced or disseminated without the express written permission of Productivity Inc. The content must not be altered, nor have the Productivity name removed from the materials. This training manual is a guide for the operation of the Machine Tool.

The Operator is responsible for following Safety Procedures as outlined by their Instructor or the Manufacturers Specification. Downloading and/or other use of this manual does not certify the completion of the Training Course. This manual is for reference only.

For more information on Additional Training Opportunities or our Classroom Schedule,
Contact Productivity Inc.

☎ 763.476.8600 ☎ (800)328-3272 Toll Free

Visit us on the Web: www.productivity.com

To obtain permissions contact: ✉ trainingmn@productivity.com

[Note: Some of the content, images and screen shots included in this manual are taken from Haas manuals, controllers and web information with permission from Haas Automation Inc. 2800 Sturgis Road Oxnard CA 93030-8933](#)

Contents

INTRODUCTION TO BASIC LATHE OPERATION	5
NOTES	6
THE CARTESIAN COORDINATE SYSTEM	7
ABSOLUTE AND INCREMENTAL POSITIONING	11
MACHINE HOME POSITION.....	13
TOOL GEOMETRY.....	14
THE HAAS NEXT GENERATION CONTROL	17
POWERING ON THE MACHINE	17
CONTROL DISPLAY.....	19
NGA CONTROL DISPLAY	20
KEYBOARD INTRODUCTION	21
NEXT GENERATION KEYBOARD CHANGES	22
1. FUNCTION KEYS.....	23
2. JOG KEYS	23
3. OVERRIDE KEYS	24
4. DISPLAY KEYS	25
OFFSET KEY	26
5. MODE KEYS	32
6. CURSOR KEYS	37
7. ALPHA KEYS.....	38
SETTINGS.....	52
HYDRAULIC TAILSTOCK OPERATION	56
<i>TOOL ROOM LATHE ORIENTATION AND WALK AROUND.....</i>	<i>59</i>
<i>POWER-UP PROCEDURES.....</i>	<i>61</i>
<i>LATHE SAFETY.....</i>	<i>63</i>
<i>EMERGENCY STOP SWITCH</i>	<i>63</i>
<i>PROPER USE OF MACHINE GUARDING.....</i>	<i>64</i>
<i>MAINTENANCE OF THE TL SERIES LATHE</i>	<i>65</i>
<i>HEADSTOCK LUBRICANT</i>	<i>66</i>
<i>GREASE POINTS</i>	<i>66</i>
<i>ALORIS TOOL POST OPERATION</i>	<i>67</i>
<i>3 JAW SCROLL JAW CHUCK OPERATION</i>	<i>68</i>
HAAS VISUAL PROGRAMMING SYSTEM (VPS).....	69

Introduction to Basic Lathe Operation

Welcome to Productivity, Inc., your local Haas Factory Outlet (H.F.O.) for the Haas Lathe Operator Class. This class is intended to give a basic understanding of the set-up and operation of a Haas Turning Center.

In an "NC" (Numerically Controlled) machine, the tool is controlled by a code system that enables it to be operated with minimal supervision and with a great deal of repeatability. "CNC" (Computerized Numerical Control) is the same type of operating system, with the exception that a computer monitors the machine tool.

The same principles used in operating a manual machine are used in programming an NC or CNC Machine. The main difference is that instead of cranking handles to position a slide to a certain point, the dimension is stored in the memory of the machine control **once**. The control will then move the machine to these positions each time the program is run.

The operation of the SL-Series Vertical Turning Center requires that a part program be designed, written, and entered into the memory of the control. There are several options for getting these programs to the control. Ethernet / Networking/ and USB are all viable ways to transmit and receive programs.

In order to operate and program a CNC controlled machine, a basic understanding of machining practices and a working knowledge of math is necessary. It is also important to become familiar with the control console and the placement of the keys, switches, displays, etc., that are pertinent to the operation of the machine.

At Productivity, we have three classes that pertain to Haas Turning Centers. The one we are in right now is the Operator Class. We also have a Haas Lathe Programming class and Lathe Live Tooling class.

We have three classes to fill the different needs of our customers as not all people that require training require programming training.

We will provide the Programming Manual on request in order to give everyone the opportunity to study G&M code lathe programming, but we also go over some programming basics in the class so that the operator can understand the programmer's intentions.

(Updated CK 12/7/18) Rev 8-2018

The Cartesian Coordinate System

The first diagram we are concerned with is called a NUMBER LINE. This number line has a zero-reference point location that is called an ABSOLUTE ZERO and may be placed at any point along the number line.

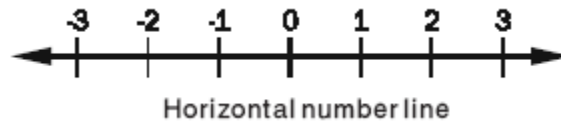

The number line also has numbered increments on either side of absolute zero. Moving away from zero to the right are positive increments. Moving away from zero to the left are negative increments. The "+", or positive increments, are understood, therefore no sign is needed. We use positive and negative signs along with increment values to indicate its relationship to zero on the line.

Our concern is the distance and the direction from zero and is labeled as "Absolute Programming"

Remember that zero may be placed at any point along the line, and that once placed, one side of zero has negative increments and the other side has positive increments.

Vertical Number Line known as the "X" axis on a Lathe

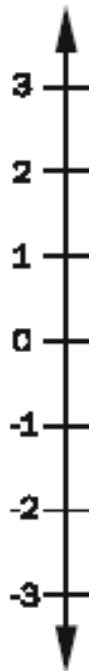

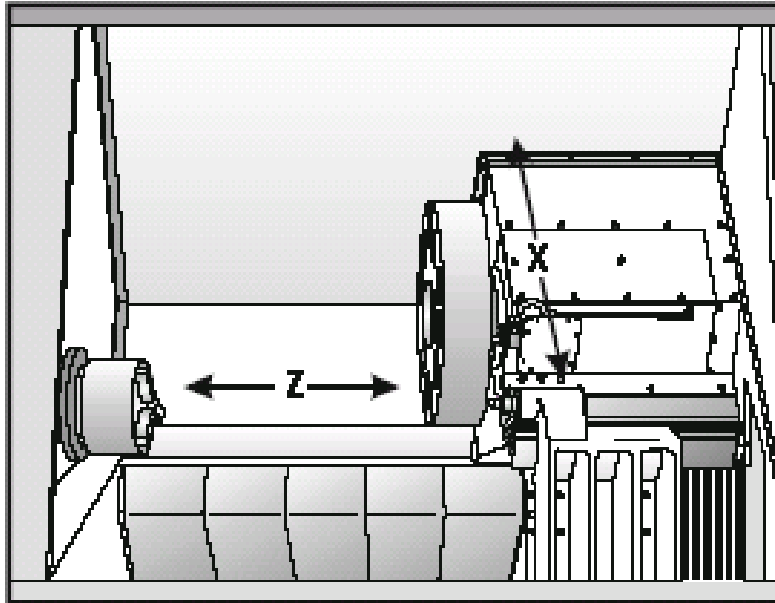

Haas Lathe X and Z axis lines

Haas SL-10 showing the X and Z axis

The machine illustration shows two directions of travel available on a turning center. Now to carry the number line idea a little further, imagine such a line placed along each set of travels (or axis) of the machine. The first number line would be the left-to-right, or “Z”, axis of the machine. Positive Z values would move the turret away from the chuck, negative values towards the chuck.

If we place a similar number line along the front-to-back movement, or “X” axis, this moves the turret to and from the centerline of the spindle of the machine. The X-Axis is programmed for diametrical values. That means when we tell the machine to move an X-dimension, it will place the tool at the position in which it will generate that diameter. Since this is a lathe, to make a 1.0000 diameter part, the tool needs to be .5000 above the center of the spindle.

All axes of Haas Turning Centers have a resolution of .0001” inches (or .001mm).

Now theoretically all of our number lines for each axis are infinite in length but we are limited to the travels of the particular machine we are using. Below is an example of the travels of different Haas Turning Centers showing how much movement we have on each particular model.

See “Turning Center Max Cutting” chart on the next page.

Turning Centers Max Cutting

Maximum Cutting Diameter and Lengths of Various Haas Lathes

Model	Max Cutting Diameter	Max Cutting Length	Chuck Size	Bar Capacity
OL-1	1.06"	8.0"	4"	1.06"
ST-10	14.0"	14.0"	6"	1.75"
ST-15	14.0"	14.0"	8"	2.5"
ST-20	15.0"	21.0"	8"	2"
ST-20SSY	10.0"	21.0"	8"	2"
ST-25	15.0"	21.0"	10"	3"
ST-30	21.0"	26.0"	10"	3"
ST-35Y	18.0"	23.0"	12"	4"
ST-40	25.0"	44.0"	15"	4"
TL-1	16.0"	29.0"	8"	2.03"
TL-2	16.0"	48.0"	10"	3.0"
DSL-30Y	18.0"	23.0"	8"	2.0"

Note ST15 is big bore variant of ST10, ST25 a big bore of ST20 and so forth. Note the on these lathes a larger chuck is put on the lathes with a 5 addition.

The diagram below shows a front view of the grid as it would appear on the lathe. This view shows the X and Z axis' as the operator faces the lathe.

Note that at the intersection of the two lines, a common zero point is established.

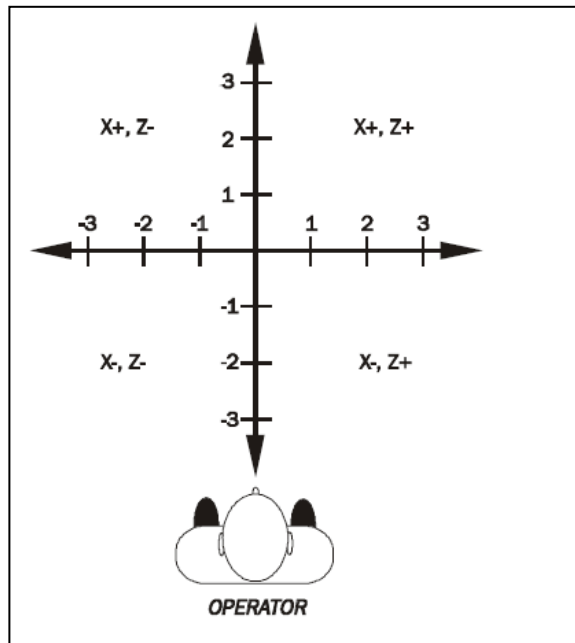

“QUADRANTS” are the four areas to the sides, above, and below the lines and make up the basis for what is known as rectangular coordinate programming.

- QUADRANT 1 - ON THE TOP RIGHT X+, Z+**
- QUADRANT 2 - ON THE TOP LEFT X+, Z-**
- QUADRANT 3 - ON THE BOTTOM LEFT X-, Z-**
- QUADRANT 4 - ON THE BOTTOM RIGHT X-, Z+**

Whenever we set a zero somewhere on the X-axis and somewhere on the Z-axis, we have automatically caused an intersection of the two lines. The intersection where the two zeros come together will automatically have the four quadrants to its sides, above, and below it. How much of each quadrant that is accessible is determined by the placement of the zeros on the travel axes of the lathe.

For example, if we set zero exactly in the middle of the Z-axis and set the X-axis zero on the spindle centerline, we have created four quadrants. For an ST30, for example, the upper two quadrants of the Z travel is 26 inches and the X travel diametrically is 21.00 inches. The lower two quadrants will have Z travel of 26 inches and diametrical X travel of 5 inch. The HAAS SL30 lathe has a radial 2 ½” of negative travel beyond the centerline of the spindle.

Absolute and Incremental Positioning

By using our WORK OFFSETS we can establish a common point on our part as a “ZERO”. This is some point on our part that we can physically find. The programmer uses this point as a base to write the intended movement of our tooling.

The most common method is to use the front end of our finish machined part (**Z Zero**) and the centerline of our part (**X Zero**).

There are two methods used by the programmer to “Steer” our machine. The first is “**ABSOLUTE POSITIONING**”. Absolute means that we input code that is based on this **ZERO POINT** on our part. If we want a diameter of 1.0000 inches, it is input as X1.0000. If we need to face a shoulder that is 3 inches back from the front of the part, we input Z-3.0000

The programmer has another tool available to him called “**INCREMENTAL POSITIONING**”. This is movement based on where the machine is currently sitting. If we wanted to change the diameter of the machine from where it is currently sitting a half a inch smaller, we would input U-.5000. If we had a grooving tool making a groove that is located $\frac{3}{4}$ ” behind a groove we already finished, we can input W-.7500

The letters X&Z represent ABSOLUTE POSTIONING

The letters U&W represent INCREMENTAL POSTIONING

If you are familiar with the mill programming language, absolute and incremental are handled differently for Mills and Lathes. A mill uses G codes (G90 and G91) to go back and forth between the two. Where as a lathe uses the different letters to differentiate them.

QUESTION:

Why doesn't a lathe take G90 and G91 like a mill?

ANSWER:

A lathe has the unique possibility to do Absolute AND Incremental moves AT THE SAME TIME.

The programmer can place an ABS. letter and an INC. letter on a line of code together, and is most commonly used in making tapers and radius moves.

G01 X2.000 W-.25 (Move X in Absolute, Z in Incremental)

or

G01 U.5000 Z-.5000 (Move X in Incremental, Z in Absolute)

All X and U dimensions are diametric!

THE CARTESIAN COORDINATE SYSTEM

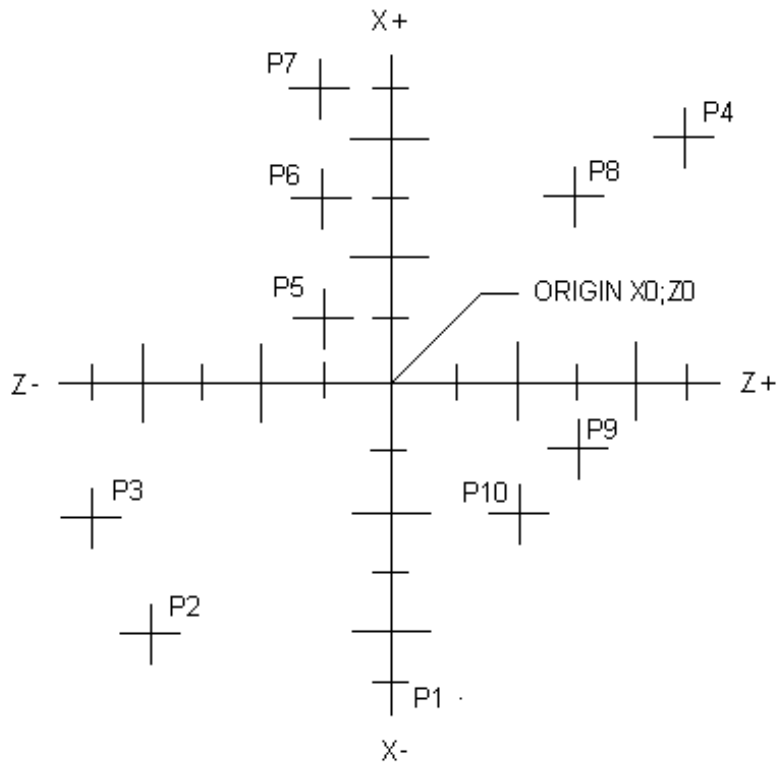

Coordinate exercise: Give X and U values as diameters.

ABSOLUTE

<i>P1</i>	<i>X-5.0</i>	<i>Z0</i>
<i>P2</i>		
<i>P3</i>		
<i>P4</i>		
<i>P5</i>		
<i>P6</i>		
<i>P7</i>		
<i>P8</i>		
<i>P9</i>		
<i>P10</i>		

INCREMENTAL

<i>P1</i>	<i>U-5.0</i>	<i>W0</i>
<i>P2</i>		
<i>P3</i>		
<i>P4</i>		
<i>P5</i>		
<i>P6</i>		
<i>P7</i>		
<i>P8</i>		
<i>P9</i>		
<i>P10</i>		

Machine Home Position

The principle of machine home may be seen when doing a manual reference return of all the machine axes. When a zero return (**POWER UP/RESTART**) is performed when the machine is first powered up, all axes are moved to the furthest positive direction until the limit switches are reached. First the X moves in a positive direction until it reaches a limit switch. Then the Z moves in a positive direction until its limit switch is reached. After the HOME position is reached the turret indexes to tool #1. The machine then sets this position as machine home where $X = 0$ and $Z = 0$. When this condition is satisfied, the only way to move any of the two axes is in the negative direction. The **machine coordinates at machine home are X0 Z0**.

Machine Home is placed at the edge of each axis' travel. In effect, the positive quadrants cannot be reached, and all the X and Z moves will be found in the $-X - Z$ quadrant. Other quadrants are reached only by setting a part zero somewhere within the travel of each axis.

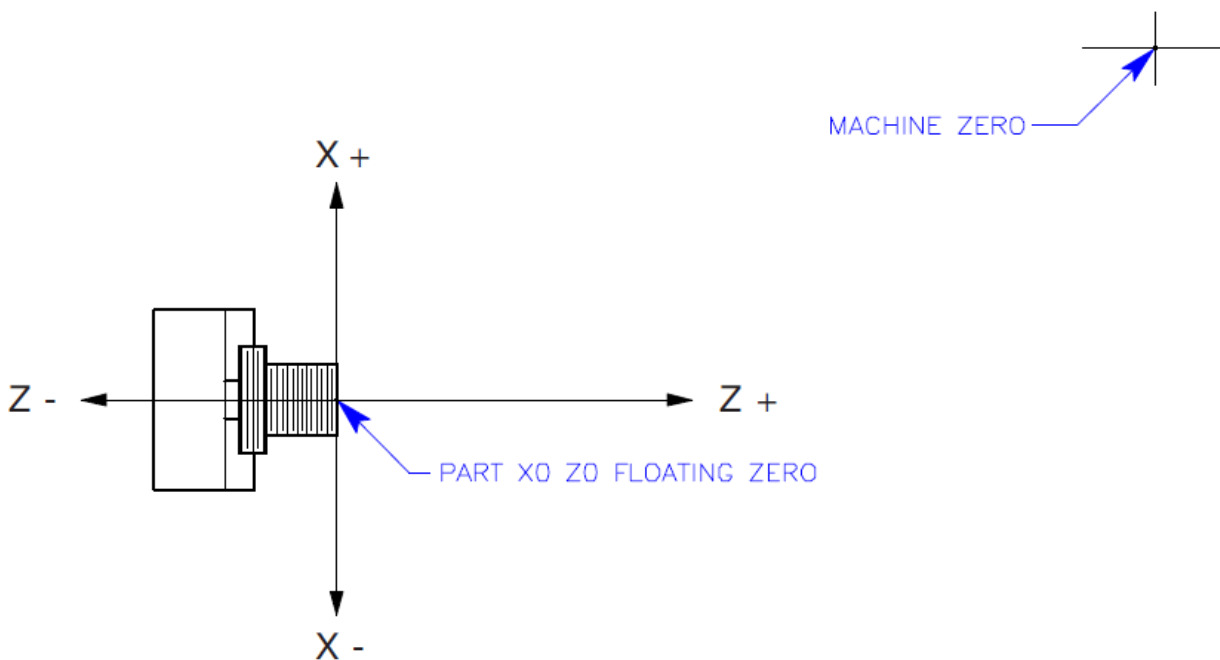

At the power-on or start-up of the Haas lathe, a Machine Zero Return operation must be performed using the key: (**POWER UP/RESTART**). The machine may also be sent home by 1st pressing the **ZERO/RET** then the **AUTO ALL/AXES** or **HOME /G28**.

It would not be convenient to program our parts from the machine zero, so a secondary zero is established. This zero is referred to by one of two names: **FLOATING ZERO** OR **PART ZERO**, both having the same meaning. See the illustration above.

Tool Geometry

To create the floating or part zero, each tool is manually moved to the part being machined and touched to the diameter and length of the part before machining starts. Then, through a series of control keystrokes, the distance from machine zero to the part zero in X and Z is stored and activated later from the part program when that tool is needed for cutting the part.

The ability to establish a “floating zero” means that the “Z” zero will be allowed to “float” to any face on the part that reflects most of the length dimensions or is a primary datum. Normally, the **front face** is used because it provides easy access for the touch-off procedure. Programming in this manner ensures continuity between the part print dimensions and the HAAS part program dimension moves.

Manual Touch-Off Method:

First select and index to an 80 degree cutting tool with standard CNMG insert configuration. This is the tool that normally would be used for rough facing and turning operations. Normally it is in tool holder #1 in the turret. First take machine turret to a safe index position utilizing buttons **ZERO/RET AND AUTO/ALL AXES OR HOME/G28**. Index to tool #1 in MDI mode (pressing **MDI/DNC**). Key in **T1** and press **TURRET/FWD** or **TURRET/REV** key.

Start spindle while in the Jog Mode (press **HANDLE/JOG**) key in 800 and press spindle **FWD** key. This will start the spindle rotating at 800 rpm.

Manually position the tool in front of the part to take a skim cut on the outside diameter using the hand wheel in the **HANDLE/JOG** mode. Take a skim cut by moving turret in the Z direction, then off the part in Z so an outside diameter measurement may be made with a micrometer. Go to Tool Geometry page by pressing **OFFSET**. Cursor to tool number 1 and press **X DIA MESUR**. The control will prompt for a diameter. Key in the value of the outside diameter measured and press **WRITE/ENTER**. The control will then calculate the position from home to the centerline of the part (Tool Geometry for X) by adding the current machine coordinate position of the turret to the negative value of the diameter which was measured.

Next manually position turret to take a skin face cut and face off the front of the part. Move tool off the part in X then press **Z FACE MESUR**. The control will record the current machine coordinate in Z into the Z register for tool # 1. The rest of the OD tools may be determined in a similar fashion.

Drills need not be touched off as centerline has been established when the machine was initialized. To enter the established centerline, cursor to the **X** column for the drill in the offset page. Press **F2 in Handle Jog mode**. Z geometry for drills needs to be determined by touching off on the face of the part. ID tools need a drilled hole to be determined. Measuring the inside diameter by taking a cut or touching off and using **X DIA MESUR** will determine the X geometry. Z geometry for ID tools is determined in similar fashion as OD tools.

Below shows the total travel capability of a ST20YSS lathe. Note the tool shown below can go past the centerline of the part to the other side of the chuck. The reason for this is so the live tooling on the face of the lathe can get to and past the centerline of the part.

Total travel of ST20YSS Lathe shown in crossed hatch

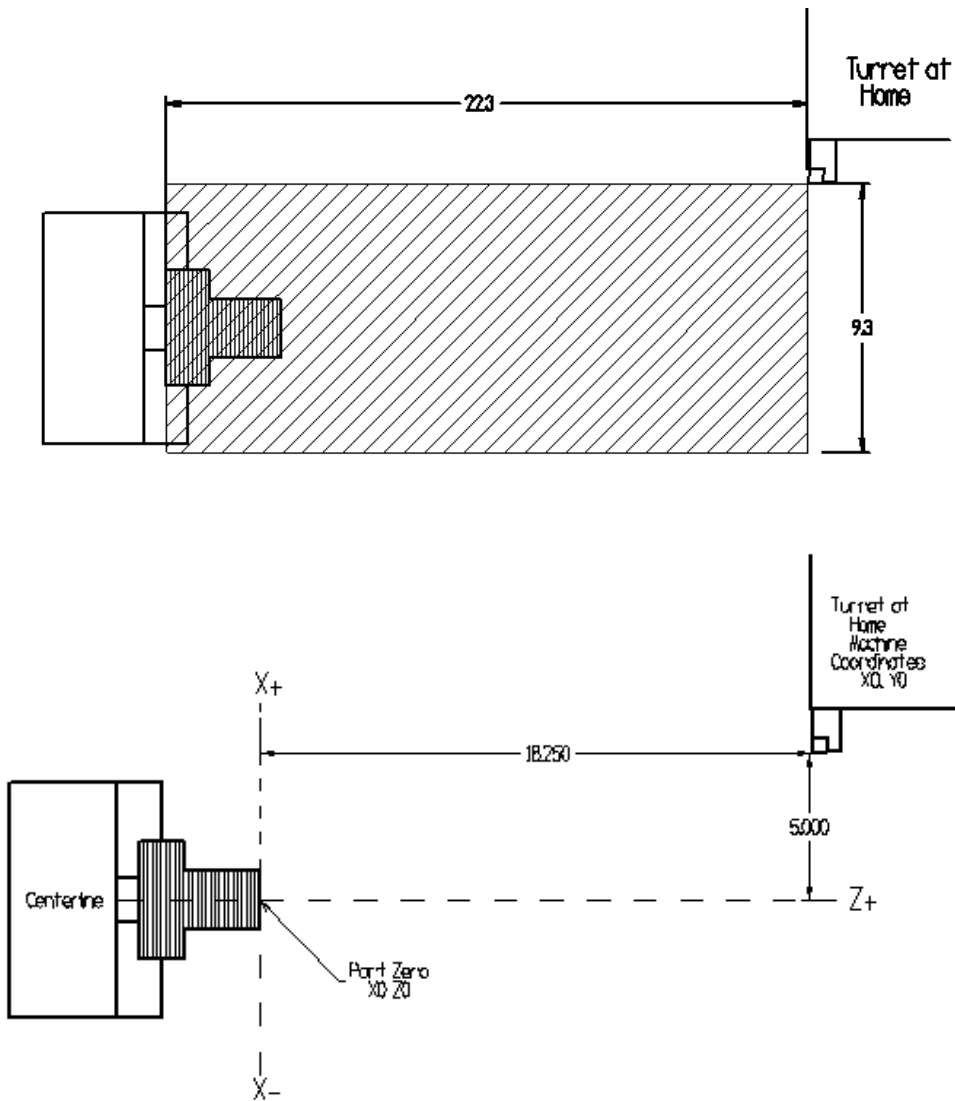

Above shows the dimensions in X and Z from home position to the face and centerline of the part in the chuck. Manually touching off on the face and a known diameter will give the following values using the Z Face Measure key and the X Diameter Measure key respectfully in the Tool Geometry Page for Tool #1. Note the 5.0 dimension from above has been taken times 2. This is because all offset values in X are in **Diameters**. Also all X's in the program are in diameters.

(Tool Geometry)
T 1 X-10. Z-18.25

On the Work Zero Offset page the **Z** in whatever work offset you are using **must be set to 0** if you are **manually touching off**. Normally the default is used G54. On the **work offset page the X must always be set to zero**.

Work Zero Offset
G54 X0 Z0

Using the **manual** method all tools must be **retouched off in the Z** for a different length part.

Probe Presetter Touch-Off Method:

Below shows the same part but the tool has been touched off using the probe. Note the tool geometry in X is the same as using the manual method. The Z however is much smaller. The difference is made up in the work zero offset in Z. (-14.5 plus $-3.75 = -18.25$).

The advantage of using the tool presetter is that it is faster than manually touching off on the face or od of a part. Also once the tools are set using the probe they don't need to be retouched off in the Z. For a different length parts all that needs to be done is reset the Work Zero Offset in Z.

(Tool Geometry)
T 1 X-10. Z-14.5

Work Zero Offset
G54 X0 Z-3.75

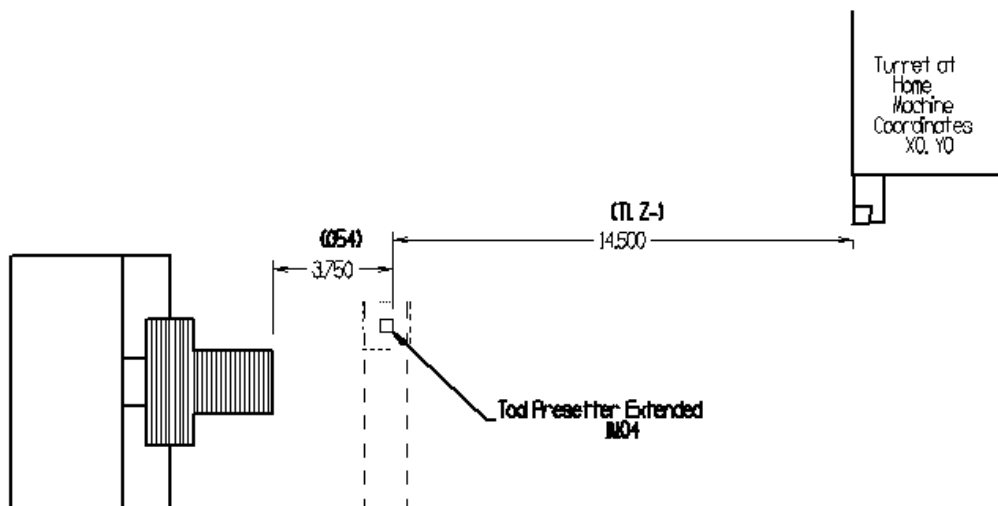

The Haas Next Generation Control

Powering On the Machine

To power up a Haas machine press **POWER ON**. First the software will load. A turning Haas logo appears while the software is loading up. Then a Start Up menu appears. The door must be cycled and the [Emergency Stop] must be reset. The Haas machine tool must first find its fixed machine zero reference point before any operations can occur. After the software is loaded press the [**RESET**], then the [**POWER UP**] key.



The following pop up comes up so the machine does not index into the tail stock on start up. If the tool room lathe has a four position turret when it is at home in Z a drill type tool may index into the tail stock on start up.

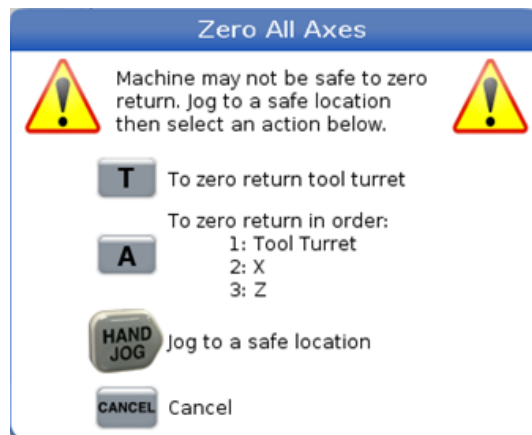

Above pressing the Hand Jog allows the turret to be position away from the tail stock. By pressing the T key will return the tool turret to zero position.

Then the lathe machine may then safely return to machine zero reference location in X and Z.

This establishes the machine home position.

Press any of the following: [Cancel] to clear the startup screen, [CYCLE START] to run current program or [HANDLE JOG] for manual operation.

General Machine Keys

Power On - Turns CNC machine on.

Power Off - Turns CNC machine tool off.

Emergency Stop - Stops all axis motion, stops spindle, tool changer and turns off coolant pump.

Jog Handle – Jogs axis selected, also may be used to scroll through programs, menu items while editing and also altering feeds and speeds.

Cycle Start – Starts program in run mode or graphics mode.

Feed Hold – Stops all axis motion. Spindle will continue to turn.

Reset – Stops machine, will rewind program.

Power Up/Restart – Axis will return to machine zero and tool change will occur per Setting 81

Recover – If a tool change is stopped in middle of a cycle an alarm will come up. Push the **Recover** button and follow the instructions to bring the tool change cycle to the beginning.

Control Display

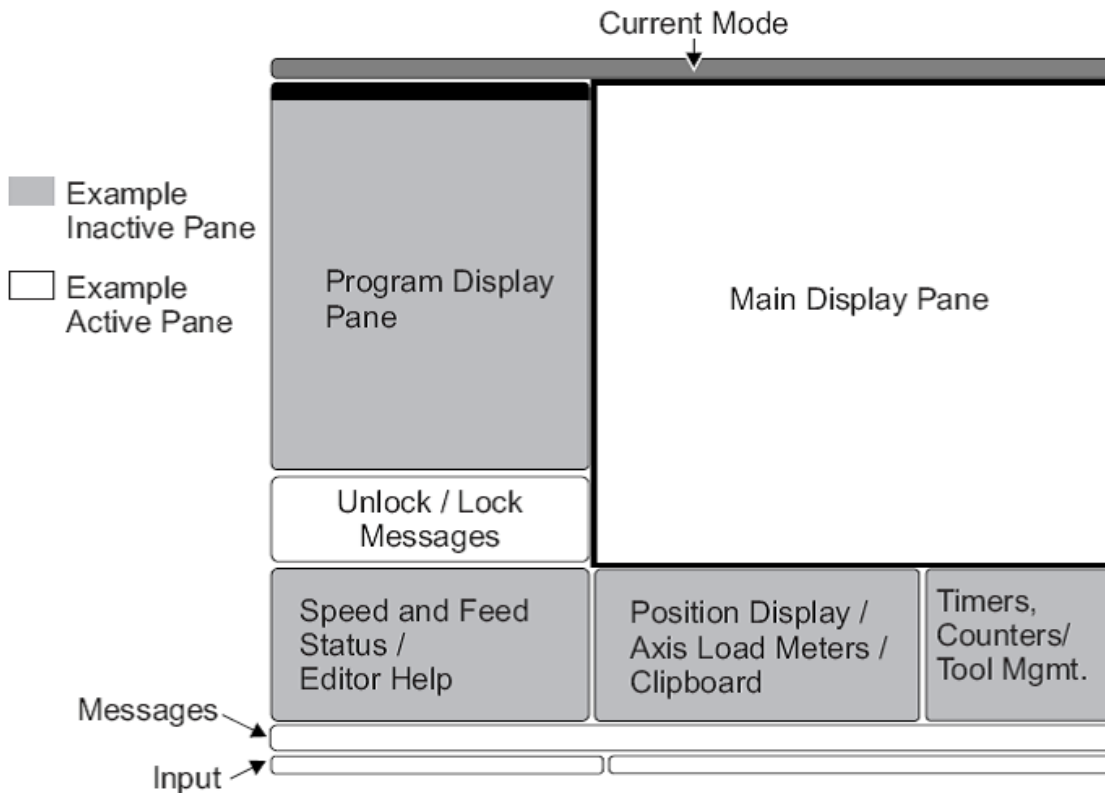

The 16 software has a larger display and more panes than older versions. Above is the basic display layout. What is displayed depends on which display keys have been used. The only pane active is the one with the white background. Only when a pane is active may changes be made to data.

Control functions in Haas machine tools are organized in three modes: **Setup, Edit and Operation.**

Access Modes using the mode keys as follows:

Setup: ZERO RET, HAND JOG keys. Provides all control features for machine setup.

Edit: EDIT, MDI/DNC, LIST PROG keys. Provides all program editing, management, and transfer functions.

Operation: MEM key. Provides all control features necessary to make a part.

Current mode is displayed at top of display.

Functions from another mode can still be accessed within the active mode. For example, while in the Operation mode, pressing OFFSET will display the offset tables as the active pane in the Main Display Pane and offsets may be altered; press OFFSET to toggle the offset display. While running a part in operation mode another program may be edited in the Main Display Pane. Press PROGRM CONVRS in most modes to shift to the edit pane for the current active program.

NGA Control Display

Below is a screen shot of the new NGA display.

The screenshot shows the NGA Control Display interface in Memory Mode. The top status bar displays 'Operation: MEM' and '14:00:17'. The 'Active Program' section shows 'MEM Memory/O00452.nc N1'. The 'Program Display' window on the left shows the following code:

```

000452 ( INGERSOL HFO DEMO G59 );
T11 M06 ( 3.0 DIPOS HEXA FACEMILL );
T12 (NO D VALUES FOR ANY TOOLS REQUIRED);
S764 M03;
G59 G90 G00 X-2.4 Y-4.1;
;
G43 Z0.2 H11;
G00 Z0;
G01 Y4.4 F32.;
G00 Z0.2;
G00 X-0.3 Y-4.1;
G00 Z0;
G01 Y4.4;
G00 Z0.2;
G00 X1.8 Y-4.1;
G00 Z0;
G01 Y4.4;
G00 Z0.1;
G53 Z0;
M01;
;
T12 M06 (1 INCH TREQ);
T14;
G00 G90 G59 X3.6835 Y0.6047 S2700 M03;
G43 H12 Z0.1;
G01 Z-0.2 F40.;
G41 D12 X3.6965 Y0.5564;
G03 X3.4 Y0.17 I0.1035 I-0.3864;
    
```

The 'Main Display Panel' is divided into three sections: 'Active Codes' (G00 Rapid Motion, G99 Feed Per Revolution, G40 Cancel Tool Nose Compensation, G80 Cycle Cancel, G54 Work Offset: #54), 'Active Tool' (Tool: 7, Offset: 7, Type: None, Tool Group: -----, Max Load: 0, Life: 100%), and 'Coolant' (Off). The 'Spindle' section shows 'Main Spindle' with a 'STOP' icon, 'Overrides' (Feed: 100%, Spindle: 100%, Rapid: 100%), and 'Spindle Load' (0%). The 'Positions' section shows 'Program G54 T707' with 'X' (0.0000, 46% Load), 'Z' (0.0000, 0% Load), and 'B' (0.0, 0% Load). The 'Timers And Counters' section shows 'This Cycle: 0:00:58', 'Last Cycle: 0:00:58', 'Remaining: 0:00:00', and 'M30 Counter #1: 0', 'M30 Counter #2: 0', 'Loops Remaining: 0'. The bottom status bar shows 'SIM: L' and 'Setup'.

Above is a view of the control panel in Memory Mode with the Program Key active on the Display Key. The Main Display Panel varies according to which of the DISPLAY keys are active.

Keyboard Introduction

The keyboard is divided into eight different sectors: Function Keys, Jog Keys, Override Keys, Display Keys, Cursor Keys, Alpha Keys, Number Keys and Mode Keys. In addition, there are miscellaneous keys and features located on the pendant and keyboard which are described briefly on the following pages.

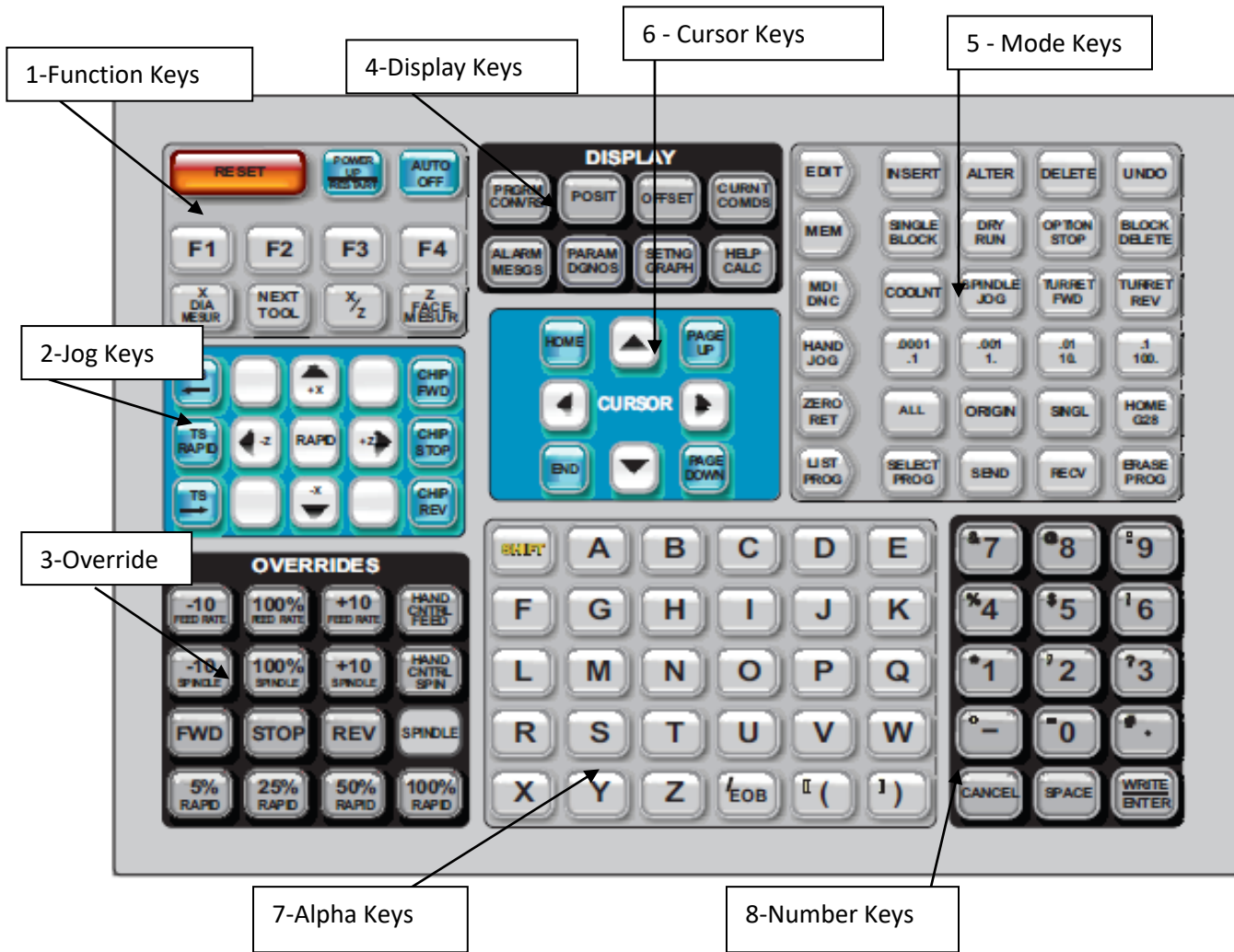

Next Generation Keyboard Changes

Only four keys have been changed on the keyboard with the NGA Control

The [DRY RUN] KEY has been changed to the [GRAPHICS] KEY.

The NGC does not provide the Dry Run option as in older controls.

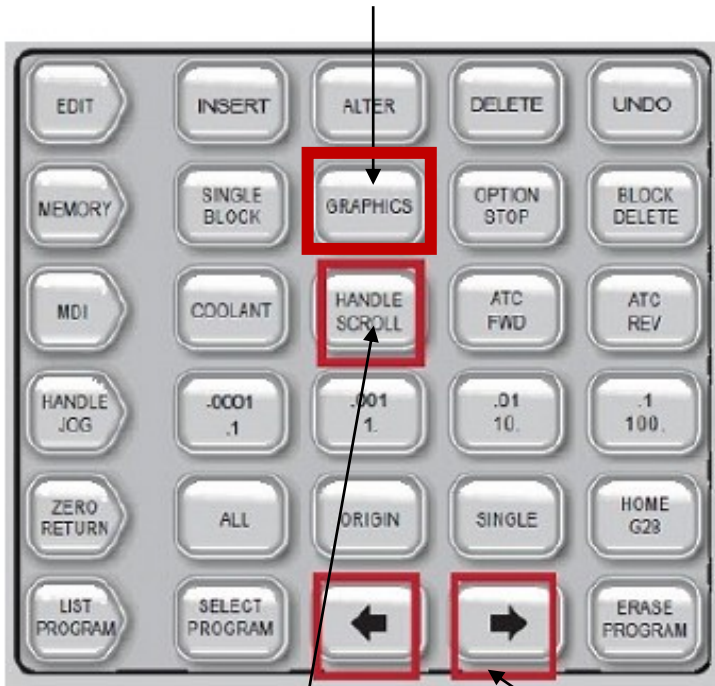

The [SPINDLE JOG] KEY has been changed to the [HANDLE SCROLL] KEY.

This allows the handle jog wheel to be used to scroll thru offsets or a program.

If you want to orient the spindle, the M19 command must be run in the MDI mode.

The [SEND] AND [REC] KEYS have been changed to FORWARD and BACK KEYS.

These keys allow navigation forward and backward thru page history.

NGC does not come with a RS232 port.

Only USB, Ethernet connections are available or an upgrade to WIFI.

1. Function Keys

F1 – F4 – Perform different functions depending on which mode the machine is in. Example in offsets mode F1 will directly enter value given it into offset geometry.

X DIAMETER MEASURE – Will take machine X position ask for a diameter measurement on the part which tool turned and put correct X Geometry in Tool Offsets page.

NEXT TOOL – In set up this will select the next tool and make a tool index.

X/Z - Toggles between X-axis and Z-axis jog modes during a set up.

Z FACE MEASURE – Used to record Z tool offsets and Z work offsets.

2. Jog Keys

Chip FWD (*Chip Conveyor Forward*) – Turns the chip conveyer in a direction that removes chips from the work cell.

Chip STOP (*Chip Auger Stop*) – Stops chip conveyer movement.

Chip REV (*Chip Auger Reverse*) – Turns the chip conveyer in reverse.

<-TS – Moves tailstock toward the spindle.

TS Rapid – Increases speed of tailstock movement when used concurrently with the other **TS** keys.

->TS - Moves tailstock away from spindle.

+X, -X (*Axis*) Selects the X axis for continuous motion when depressed.

+Z, -Z (*Axis*) Selects the Z axis for continuous motion when depressed.

Rapid – When pressed simultaneously with X or Z keys will move at maximum jog speed.

3. Override Keys

The overrides are at the lower right of the control panel. They give the user the ability to override the speed of rapid traverse motion, as well as programmed feeds and spindle speeds.

- 10 FEED RATE** Decreases current feed rate in increments of 10 percent.
- 100% FEED RATE** Resets the control feed rate to the programmed feed rate.
- +10 FEED RATE** Increases current feed rate in increments of 10 percent.
- HANDLE CONTROL FEED RATE** Hand wheel will control feed rate at 1% increments.

- 10 SPINDLE** Decreases current spindle speed in increments of 10 percent.
- 100% SPINDLE** Sets the control spindle speed at the programmed spindle speed
- +10 SPINDLE** Increases current spindle speed in increments of 10 percent.
- HANDLE CONTROL FEED** Hand wheel will control feed rate at 1% increments.

- CW** Starts the spindle in the clockwise direction.
- STOP** Stops the spindle.
- CCW** Starts the spindle in the counterclockwise direction.

- 5% RAPID** Limits rapid moves to 5 percent of maximum.
- 25% RAPID** Limits rapid moves to 25 percent of maximum.
- 50% RAPID** Limits rapid moves to 50 percent of maximum.
- 100% RAPID** Allows rapid traverse to feed at its maximum.

Override Usage

Feed rates may be varied from 0% to 999%. Feed rate override is ineffective during G74 and G84 tapping cycles. Spindle speeds may be varied from 0% to 999%. Depressing Handle Control Feed rate or Handle Control Spindle keys, the jog handle movement varies by +/-1% increments.

Setting 10 will limit rapid movement to 50%.

Settings 19, 20, 21 make it possible to disable override keys.

Coolant may be over rode by depressing **COOLNT** button.

Feed Hold - Stops rapid and feed moves. **Cycle Start** button must be depressed to resume machine feeds. Similar situation applies when Door Hold appears. Door must be closed and **Cycle Start** pressed to continue running program.

Overrides may be reset to defaults with a M06, M30 or pressing **RESET** by changing Settings 83, 87 and 88 respectively.

4. Display Keys

POSITION KEY

Display keys determine what is shown in the Main Display Panel.

Below the **[POSIT]** Display Key is active in the Memory Mode.

Tabs highlighted in orange tell you what axis you will see. Below the All tab is active.

Machinist's when they are setting up like to have the All tab highlighted. It shows where they are at with respect the part zero. Also the distance to go before the next block is shown.

The screenshot displays the CNC control interface. The top left shows the operation 'MEM' and time '14:30:58'. The main window is titled 'Positions' and has tabs for 'Program', 'Distance To Go', 'Machine', 'Operator', and 'All' (highlighted in orange). The 'All' tab is active, showing a table of positions in inches (IN) for axes X, Z, and B. The table is divided into two sections: 'G54 T707' and 'Machine'. The 'G54 T707' section shows positions for X, Z, and B axes with values 0.0000, 0.0000, and 0.0 respectively. The 'Machine' section shows positions for X, Z, and B axes with values 0.0000, 0.0000, and 0.0 respectively. Below the table is an 'ALTER' button with the text 'To view options.'.

The bottom left shows the 'Spindle' status. The 'Main Spindle' is stopped, indicated by a red 'STOP' sign. The spindle speed is 0 RPM, spindle load is 0.0 KW, and surface speed is 0 FPM. The feed rate is 0.0000 FPM, chip load is 0.00000, and active feed is 0.0000. The spindle load percentage is 0%.

The bottom right shows the 'Timers And Counters' section. The 'This Cycle' timer is 0:00:58, the 'Last Cycle' timer is 0:00:58, and the 'Remaining' timer is 0:00:00. The 'M30 Counter #1' and 'M30 Counter #2' are both 0, and the 'Loops Remaining' is 0.

By depressing the **[ALTER]** key the display may be customized as shown below:

The screenshot shows the 'Positions' window with a custom configuration. The 'All' tab is still active. The table of positions is the same as in the previous screenshot. However, the 'ALTER' button is now highlighted in orange, and the 'X' axis is selected in the configuration panel on the right. The configuration panel has checkboxes for 'X', 'Z', and 'B' axes, with 'X' checked. Below the checkboxes are three buttons: 'ORIGIN' (Reset), 'ALTER' (Close), and 'ENTER' (Select).

OFFSET KEY

The **[Offset Key]** is active below.

Tool Geometry values are shown along with Radius size. If tool life management is being used red will indicate the tool life has expired, yellow is a warning.

Offsets			
Tool	Work		
Active Tool: 1			
Tool Offset	X Geometry	Z Geometry	Radius Geometry
1 Spindle	-15.0000	-16.0000	0.0312
2	-15.0000	-16.0000	0.0156
3	-15.0000	-16.0000	0.
4	-15.0000	-16.0000	0.
5	0.	0.	0.
6	0.	0.	0.
7	0.	0.	0.
8	0.	0.	0.
9	0.	0.	0.
10	0.	0.	0.
11	0.	0.	0.
12	0.	0.	0.
13	0.	0.	0.
14	0.	0.	0.
15	0.	0.	0.
16	0.	0.	0.
17	0.	0.	0.
18	0.	0.	0.

Enter A Value

Set to VDI center line
 Set to BOT center line
 X Diameter Measure
 Set Value
 Add To Value
 Work Offset

Cursor to the right will show Wear values. Small changes due to tool wear should be put here.

Offsets			
Tool	Work		
Active Tool: 1			
Tool Offset	X Geometry Wear	Z Geometry Wear	Radius Wear
1 Spindle	-0.0050	0.	0.
2	0.0030	0.	0.
3	0.	0.	0.
4	0.	0.	0.
5	0.	0.	0.
6	0.	0.	0.
7	0.	0.	0.
8	0.	0.	0.
9	0.	0.	0.
10	0.	0.	0.
11	0.	0.	0.
12	0.	0.	0.
13	0.	0.	0.
14	0.	0.	0.
15	0.	0.	0.
16	0.	0.	0.
17	0.	0.	0.
18	0.	0.	0.

Enter A Value

X Diameter Measure
 Set Value
 Add To Value
 Work Offset

Cursor to the right again will get to the page where tool tip types are selected for tool nose compensation. Below tool 1 is an OD tool where normally type 3 is selected. Tool 2 is an ID bore tool. It is normally set up as a type 2. On the bottom of the page illustrations show the different tool types to select from.

Offsets

Tool Work

Active Tool: 1

Tool Offset	Tip	Tool Type	Tool Material	Tool Pocket
1 Spindle	3: X- Z-	OD Turn	User	1
2	2: X+ Z-	ID Turn	User	2
3	0: None	None	User	0
4	0: None	None	User	0
5	0: None	None	User	0
6	0: None	None	User	0
7	0: None	None	User	0
8	0: None	None	User	0
9	0: None	None	User	0
10	0: None	None	User	0
11	0: None	None	User	0
12	0: None	None	User	0
13	0: None	None	User	0
14	0: None	None	User	0
15	0: None	None	User	0
16	0: None	None	User	0
17	0: None	None	User	0
18	0: None	None	User	0

Enter A Value

X Diameter Measure **F1** Set Value **ENTER** Add To Value **F4** Work Offset

Tip

Going back to the first offset page cursor to the top to highlight **Tool**. Then highlight **Work**. This opens the work offsets page as below.

One may also toggle between work and tool offsets pages by using the **[F4]** key. Normally in lathes you should never have values in the X Axis.

Offsets

Tool Work

Axes Info

G Code	X Axis	Z Axis	Work Material
G52	0.	0.	No Material Selected
G54	0.	3.0000	No Material Selected
G55	0.	3.1000	No Material Selected
G56	0.	0.	No Material Selected
G57	0.	0.	No Material Selected
G58	0.	0.	No Material Selected
G59	0.	0.	No Material Selected
G154 P1	0.	0.	No Material Selected
G154 P2	0.	0.	No Material Selected
G154 P3	0.	0.	No Material Selected
G154 P4	0.	0.	No Material Selected
G154 P5	0.	0.	No Material Selected
G154 P6	0.	0.	No Material Selected
G154 P7	0.	0.	No Material Selected
G154 P8	0.	0.	No Material Selected
G154 P9	0.	0.	No Material Selected
G154 P10	0.	0.	No Material Selected
G154 P11	0.	0.	No Material Selected
G154 P12	0.	0.	No Material Selected

F1 Set Value **ENTER** Add To Value **F4** Tool Offsets

Enter A Value

PROGRAM KEY

Selects the active program pane (highlights in white). It shows the Active G and M Codes along with information on which tool is the active tool.

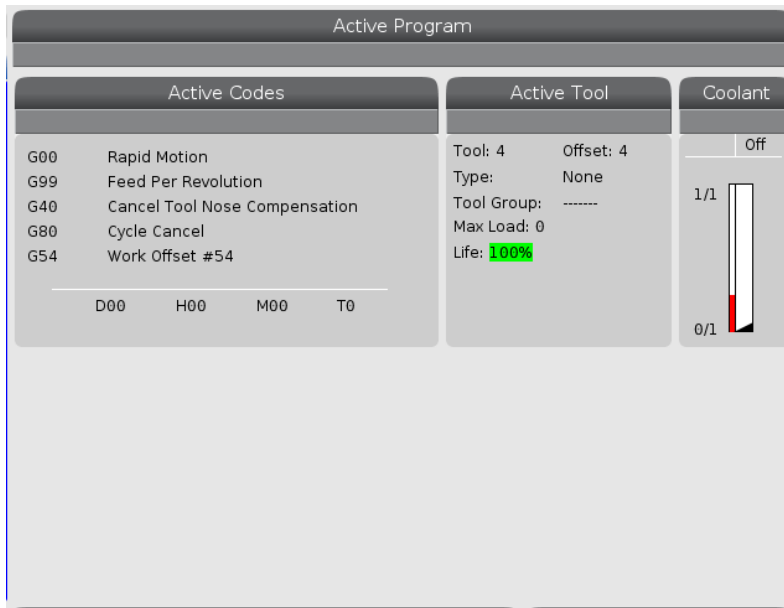

CURRENT COMMANDS KEY

The Current Commands key gives several different options.

The Devices tab shows which options the machine has. Below the Timers tab gives cycle times and also parts counters (M30 counter #1 and #2)

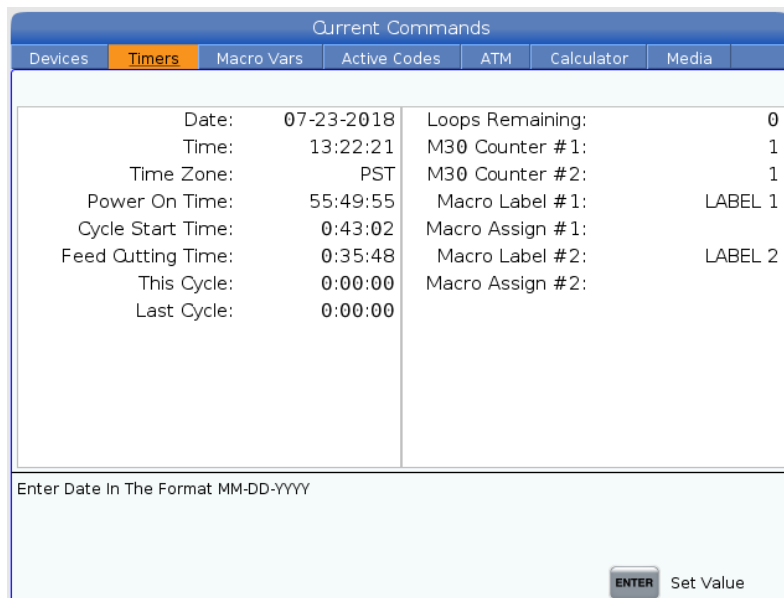

Below the Active Codes tab is highlighted. It gives G and M codes which may be helpful when trouble shooting a program.

Current Commands						
Devices	Timers	Macro Vars	Active Codes	ATM	Calculator	Media
G-Codes	Address Codes	DHMT Codes	Speeds & Feeds			
G00	N 0	D 00	Programmed Feed Rate	0.		
G18	X 0.	H 00	Actual Feed Rate	0.		
G90	Y 0.	M 00	Programmed Spindle Speed	0.		
G113	Z 0.	T 00	Commanded Spindle Speed	0.		
G20	I 0.		Actual Spindle Speed	0.		
G40	J 0.		Coolant Spigot Position			
G49	K 0.					
G80	P 0					
G99	Q 0.					
G50	R 0.					
G54	O 000000					
G97	A 0.					
G64	B 0.					
G69	C 0.					
	U 0.					
	V 0.					
	W 0.					
	E 0.					

If using macro variables in programming the Macro Vars key will give values for individual variables.

ALARMS KEY

If the machine has an alarm the definition may be found by pressing the Alarms Key. Below the machine found an invalid G code when running the program.

Alarms And Messages					
Active Alarms	Messages	Alarm History	Alarm Viewer	Key History	
Alarm [1 Total]					
310 INVALID G CODE					
<p>310 INVALID G CODE</p> <p>The control did not recognize a G-code command. The G-code command is not defined as an aliased G-code.</p> <p>If you intended to use an aliased G-code, make sure that the code is correctly defined. Press [SETTINGS] and use the Alias Codes tab to specify the G-code number for the O9xxx program that you want to alias.</p>					
HOME	END	PAGE UP	PAGE DOWN	Scroll Description	

The alarm history tab shows which alarms and dates have been seen by the machine in the past. The alarm viewer and key history may also be seen by highlighting the respective tabs.

DIAGNOSTICS KEY

The diagnostic key is primarily used by service to trouble shoot problems.

If a problem is found the service department at Productivity or Haas will ask for the type of machine (TL-1), the Serial Number and the software release number. These can be found below if the System tab is highlighted.

The screenshot shows the 'Parameters, Diagnostics And Maintenance' window with the 'System' tab selected. The window is divided into several sections:

- Diagnosics** (selected), Maintenance, Parameters, Keyboard I/O
- Gauges**, **System** (selected), I/O, MOCON
- Versions** table:

Versions	
Serial Number	899997
Model	TL
Release	100.17.000.2036
Platform	RevD_R22.02.07
Link	11/17/2017 16:51
MOCON	
FPGA	
Control	16:52:53 Nov 17 2017
SKBIF Version	4.9
RJH-C	???
SIO Version	
I/O TC Version	
I/O Version	N/A
Help Version	1

- Machine Data** table:

Machine Data	
Run Time	4:55:13
Bill Time	00:00:00
Tool Changes	5
Power Cycles	12
Power On Time	58:03:12

- Safety Levels** table:

Safety Levels	
Operator Door Safety Level	5
Load Station Door Safety Level	2
Tool Changer Cage Door Safety Level	3
Alarm Level	-

At the bottom right, there is a button labeled **F2** Legal Information.

SETTINGS KEY

The settings key controls functions that the user may turn on and off or change to suit specific needs.

Below the settings panel is active with the settings tab selected. Note settings are organized in groups. Highlight a group to open it and press right arrow key.

Page 51 in this manual gives a list of settings which are most used.

The screenshot shows the 'Settings' window with the 'Settings' tab selected. The window contains a search bar and a list of settings groups:

Search (TEXT) [F1], or [F1] to clear.

Group	
General	>
Miscellaneous	>
Program	>
Control Panel	>
Editing	>
Graphics	>
Overrides	>
Compensation	>
Power Settings	>
Probe	>
Machine Setup	>

At the bottom right, there is a button labeled **ORIGIN** Restore default settings menu.

Below the control panel group is open and the Disable .1 JOG RATE is highlighted. Pressing the right arrow key will give a drop down where the On is highlighted.

Settings

Settings Network User Positions Alias Codes

Group Listings Search (TEXT) [F1], or [F1] to clear. Control Panel

	Group	Name		Value	Unit
6	Control Panel	Front Panel Lock	>	Off	
17	Control Panel	Opt Stop Lock Out	>	Off	
18	Control Panel	Block Delete Lock Out	>	Off	
84	Control Panel	Tool Overload Action	>	Alarm	
103	Control Panel	Cyc Start/Fh Same Key	>	Off	
104	Control Panel	Jog Handl To Sngl Blk	>	Off	
163	Control Panel	DISABLE .1 JOG RATE	>	On	
240	Control Panel	Tool Life Warning		Off	
264	Control Panel	Autofeed Step Up		On	%
265	Control Panel	Autofeed Step Down		20	%
266	Control Panel	Autofeed Minimum Override		5	%

ORIGIN Restore default settings menu.

163 - Disable .1 jog Rate

This setting disables the highest jog rate. If the highest jog rate is selected, the next lower rate is automatically selected instead.

HELP View full text.

To hook machine to a network highlight the Network key. Other functions such as User Position, Haas Connect and Wireless Connection may also may be accessed thru Settings.

Settings

Settings Network User Positions Alias Codes

Wired Connection Wireless Connection Net Share Haas Connect

Wired Network Information

Host Name	HaasCNC0	DHCP Server	*
Domain		IP Address	*
DNS Server	*	Subnet Mask	*
Mac Address	00:C0:08:88:CB:F4	Gateway	*
DHCP Enabled	OFF	Status	*

Name		Value
Wired Network Enabled	>	Off
Obtain Address Automatically	>	Off
IP Address		
Subnet Mask		
Default Gateway		
DNS Server		

Warning: Changes will not be saved if page is left without pressing **F4**

F3 Discard Changes **F4** Apply Changes

HELP KEY

To Help Key basically just gets you to the machine operator manual that comes with the machine. Tables with G-codes, M-codes and operating information may be accessed thru the machine instead of the paper copy.

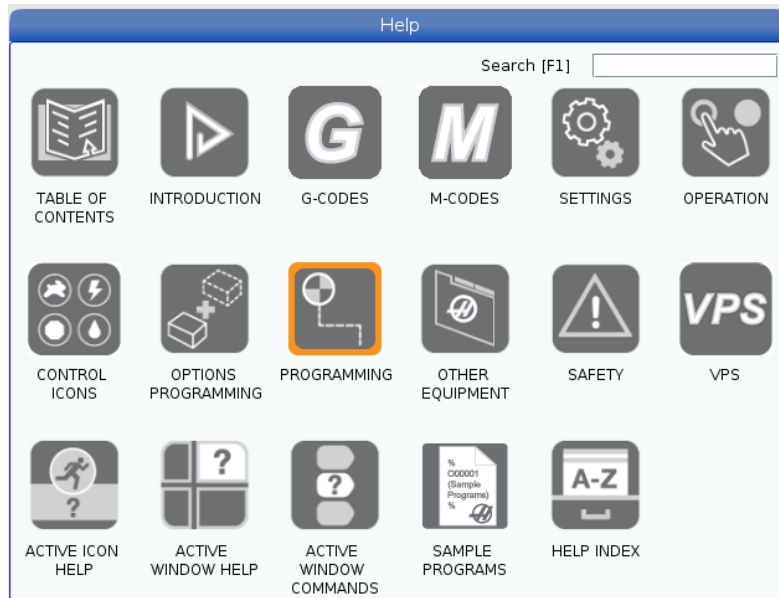

5. Mode Keys

Mode keys set the operational state of the machine tool. Once a mode is set the keys to the right may be used. The current operation mode of the machine is displayed at the top thin pane of the CRT.

GRAPHICS KEY

Programs can be *graphically* displayed in the main display screen. In this screen you can dry-run a program without moving the axes or risking tool damage from any programming errors.

1. Press either **MEM** or **MDI** and select the program that you want to run in Graphics. Graphics may also run in the Edit Mode.
2. Press Graphics Key and then Cycle Start Key. With the Graphics Key active no axis movement will occur. Below shows program O00074 run in graphics. The thin lines show roughing passes. The thick solid line shows the finish pass. The green line represents rapid moves. With the NGA control the graphics are created instantaneously. Single individual moves may be seen if the graphics are run in single block mode. F2 enables the zoom feature.

Operation: MEM | 11:09:55

MEM | Memory/O00074.nc | N20

```

O00074 (G71 TYPE II EX P99);
N1;
T1.01 (OD TOOL 1/32);
G50 S2500;
G97 S400 M03;
G54 G00 X3.6 Z0.1 M08;
G96 S375;
Z0.005;
G01 X-0.1 F0.005;
G00 X3.5 Z0.1;
G71 P10 Q20 U0.01 W0.005 D0.12 F0.011;
N10 G42 G00 X-0.05 Z0.1;
G01 Z0 F0.006;
X1.5;
G03 X1.75 Z-0.125 R0.125;
G01 Z-0.5 F0.012;
X1.25 Z-1.;
Z-2.;
X1.75 Z-2.5;
Z-3.;
G02 X2.25 Z-3.25 R0.25;
G01 X2.5;
G03 X3. Z-3.5 R0.25;
G01 Z-4.125 F0.003;
X3.5 F0.015;
N20 G40 X3.6;
G97 S400 M09;
G28.

```

Graphics

Tool: Work G54: Drill Point:

[F2]: Enable Zoom | [HOME]: Reset Zoom | [PAGE UP]: Zoom -
[ENTER]: Apply Zoom | [END]: Center Zoom | [PAGE DOWN]: Zoom +

Spindle

Main Spindle

Overrides

- Feed: 100%
- Spindle: 100%
- Rapid: 100%

Spindle Speed: 0 RPM
Spindle Load: 0.0 KW
Surface Speed: 0 FPM
Chip Load: 0.00000
Feed Rate: 0.0000
Active Feed: 0.0000

Spindle Load(%) 0%

Positions | Program G54 T401

	(IN)	Load
X	10.0000	0%
Z	8.2000	0%

Timers And Counters

- This Cycle: 0:00:00
- Last Cycle: 0:00:00
- Remaining: 0:00:00
- M30 Counter #1: 17
- M30 Counter #2: 17
- Loops Remaining: 0

Setup | Power Save | Opt Stop

SIM: |

F2 key enables the zoom function.

EDIT KEY

The edit mode is used to make changes in a program stored in the active memory. When you press **EDIT** the active program appears in an edit screen in the main display pane as below.



INSERT KEY

Enters commands keyed into the input panel in lower left pane of CRT after the highlighted word in a program.

ALTER KEY

Highlighted words are replaced by text input into the input panel.

DELETE KEY

Highlighted words are deleted from a program.

UNDO KEY

Will undo up to the last 9 edit changes.

F1 KEY

While in the edit mode pressing **F1** will open tabs inside the edit screen. Using the sideways cursor buttons will toggle thru File, Edit, Search and Modify tabs. Below shows the different options under the Edit tab. Note the Clipboard at the bottom of the screen. Text maybe copy and pasted from the clipboard.

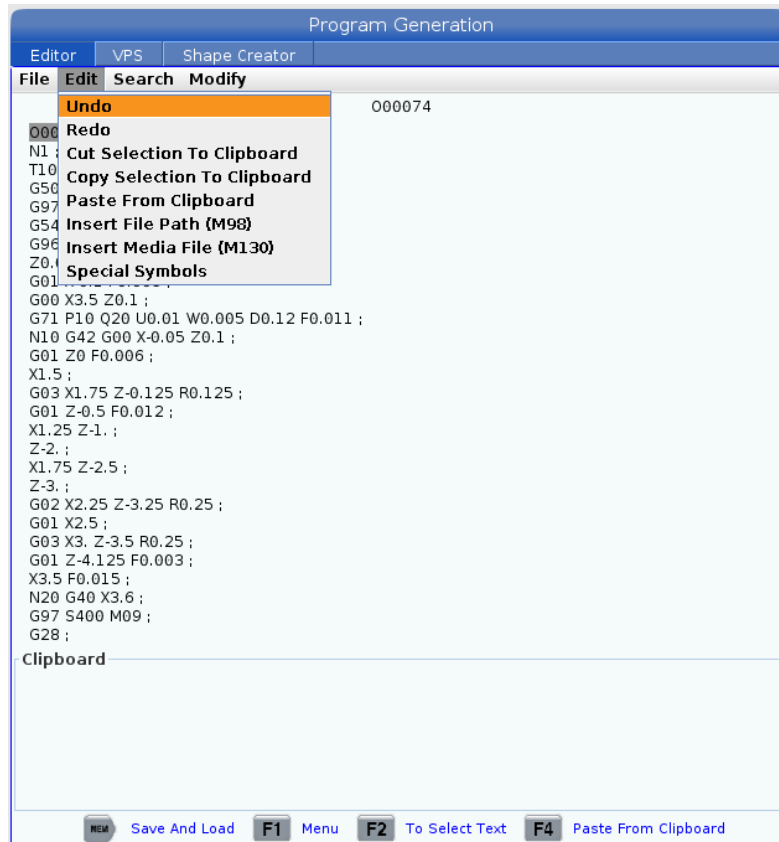

The File tab gives options of creating new program, saving, duplication of programs. The Search gives the option of searching and replacing text. The Modify key gives the ability to insert or change block line numbers.

Background

Edit

When a program is being run pushing the edit key will bring up the Background Edit pane in the Main Display Pane. Simple edits may be performed on the program that is being run or another program. The edits on the running program will not take place until after the current cycle has completed.

If changes are made using any of the above in the NGA control they must be saved using the Memory key.

In the Legacy control any changes were automatically saved.

MEMORY KEY

The memory mode is the mode used when running the machine and making a part. The active program is shown in the Program Display Pane. Keys in the memory mode line reflect different ways of running a part in memory. When the keys to the right are depressed they will show up as icons in the Icon bar at the bottom of the screen.

SINGLE BLOCK KEY

When depressed a **stairs icon** will appear in the icon bar on the bottom of the CRT. When the machine is in SINGLE BLOCK mode only one block of the program is executed every time the cycle start button is depressed. Used when first test running a program or temporarily stopping a program when it is running.

OPTION STOP KEY

When **OPTION STOP** is depressed the program will stop at any M01 which is in the program. Normally M01's are placed after a tool is run in a program. When a job is being set up the operator may put machine in op stop mode to check dimensions after every tool has completed cutting.

BLOCK DELETE KEY

When this button is depressed any block with a slash (/) in it is ignored or skipped.

MDI KEY

(MANUAL DATA INPUT) – Usually short programs are written in MDI but are not put into memory. In MDI mode the program in MDI is run when the Cycle Start key is depressed.

COOLANT KEY

Toggles coolant on and off manually.

HANDLE SCROLL KEY

Allows scrolling thru a program in edit using the handle jog wheel.

TURRET FWD KEY

Rotates turret forward to the next tool. Also used to call up specific tool numbers. Enter tool number (T1) and press **Turret Fwd**.

TURRET REV KEY

Rotates turret in reverse to a tool. Also may be used to call up specific tools. Enter tool number (T3) and press **Turret Rev**.

HANDLE JOG KEY

Puts machine in jog mode for set ups. Axis desired to move must first be selected using one of the jog keys. Top values (.0001, .001, .01, .1) represent distance traveled in inches per click of jog handle. Bottom values (.1, 1., 10., 100) represent feed in inches/minute when jogging axis using jog buttons.

ZERO RETURN KEY

On pressing position display becomes highlighted in Zero Return mode.

ALL KEY

Returns all axes to machine home in similar fashion as a Power Up/Restart.

ORIGIN KEY

Sets selected displays to zero or other functions.

SINGLE KEY

Returns a single axis to machine home. Select desired axis (X, Y, or Z) then press Single Key.

HOME/G28 KEY

Rapid motion to machine home; will make a rapid move in all axes at once - may also be used for a rapid home in one-axis. Press axis to home then **G28**. **Caution must be used that extended tools, tailstock or parts are out of the way before initiating this rapid move to home.**

LIST PROGRAM KEY

Will bring up list or directory of programs stored in the machine. Pressing Up Arrow key will return you to tab at top usually MEM or USB. Cursor to left or right for which list one wants. Pressing **Enter** will open a list of programs. Cursor UP (^) or DOWN (v) to program desired. Select the desired programs to be moved by pressing **WRITE/ENTER**. This will put a check mark beside it. **F2** will copy selected program or programs to be moved. A pop up menu will ask where you want the selected programs to be copied.

SELECT KEY

After highlighting a program from List Program with up or down cursor pressing this button will place the program in the Active Program Pane. This is the program that will run the CNC machine in the Memory mode. Use in the Edit mode in the Main Display will enter selected program in the Main Display pane for editing.

[<] AND [>] KEY

Navigation keys to go to previous pages or forward pages

ERASE PROGRAM KEY

Will erase highlighted program or programs in List Program. A prompt will appear asking if you want to delete selected program asking for Y/N. If in MDI mode will erase program in MDI.

6. Cursor Keys

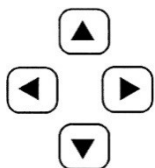

Cursor Keys The cursor keys are in the center of the control panel. They give the user the ability to move to and through various screens and fields in the control. They are used extensively for editing and searching CNC programs. They may be arrows or commands.

UP/DOWN KEY

Moves up/down one item, block or field. Will also do searches.

PAGE UP OR DOWN KEY

Used to change displays or move up/down one page when viewing a program.

HOME KEY

Will move the cursor to the top-most item on the screen; in editing, this is the top left block of the program.

END KEY

Will take you to the bottom-most item of the screen. In editing, this is the last block of the program.

7. Alpha Keys

The **Alpha Keys** allow the user to enter the 26 letters of the alphabet along with some special characters. Depressing any Alphabet Key automatically puts that character in the Input Section of the control (lower left-hand corner).



SHIFT KEY

Provides access to the yellow characters shown in the upper left corner of some of the alphanumeric buttons on the keyboard.

(OR) PARENTHESES KEYS

Parentheses are used to separate CNC program commands from user comments. They must always be entered as a pair. Example: (T1 ½" End Mill)

(-) and (.) These keys are used to define negative numbers and give decimal position.

+ = # * [] These symbols are accessed by first pressing the **SHIFT** key and then the key with the desired symbol. They are used in macro expressions (Haas option) and in parenthetical comments within the program.

, ? % \$! & @ : These are additional symbols, accessed by pressing the **SHIFT** key, that can be used in parenthetical comments.

8. Numeric Keys

The **Numeric Keys** allow the user to enter numbers and a few special characters into the control. Depressing any number key automatically puts it into the Input Section of the Control.

CANCEL KEY

The **Cancel** key will delete the last character put into the Input Section of the control display.

SPACE KEY

Is used to format comments placed into the Input Section of the control display.

ENTER KEY

General purpose "Enter" key. It inserts code from the input section into a program when the program display is in EDIT mode. With offsets pages active, pressing the **ENTER** key adds a number in the Input Section to the highlighted cell. Pressing the **F1** key will input the number into the cell.

- (MINUS) KEY

The (Minus Sign) is used to enter negative numbers.

. (DECIMAL POINT KEY)

The (Decimal Point) is used to note decimal places.

Manual Probe Touch-Off Method using Work Offset:

Swing down probe by using **M104** in MDI (**M105 retracts**). Manually bring tool close to center of probe in the X. Switch Handle/Jog to **.001 increment** and press **--X** jog key until a beep is heard. Movement will stop in the X when the beep is heard. A value will automatically be entered into X register for the particular tool. Reverse directions by pressing the **+X** key.

Z geometry values are determined in a similar fashion by manual movement and touch off in the Z direction. A similar procedure is used with ID tools. Only the ID side of the probe is touched off on. Drills are touched off in a similar fashion in the Z. Use **F2** to determine the X geometry for drills in handle jog mode. Drill geometry in **X** may also be set by sweeping in the drill pocket and entering the X machine coordinate into the X geometry column of the offset page for the drill.

Correct values for the probe are determined when the machine is installed. Over time and after a crash the probe may need to be recalibrated. A calibration procedure may be found on page ## of this manual.

When **using the probe** for touching off all the tools in the lathe **a work offset must be determined**. When the face of the part is used to touch off the tools all the Zs the work zero offset will be 0. However, when using the probe method the distance from machine home to the probe and the face of the part are different. To determine this distance press **F4** until the Work Zero Offset register appears. Highlight the Z in Work Offset to be used (G54 to G59) by using the up and down arrow cursor. Manually move any active tool up to the face of the part to be machined. Using a piece of paper, touch off the face. Press **Z FACE MESUR**. The correct work offset will be placed in the Z column. Normally the X column is always left at zero.

Automatic Tool Setting Probe

To access the automatic tool setting probe page first press the EDIT key then highlight the Editor tab as shown below.

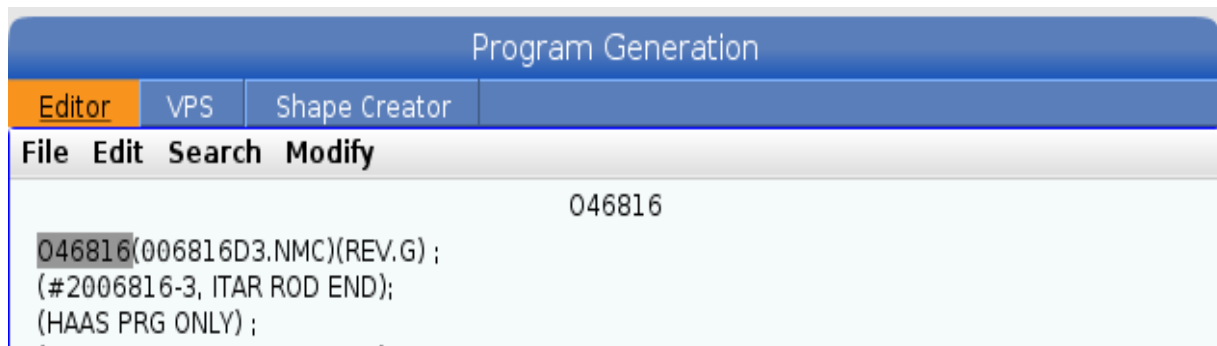

Then highlight the VPS tab by using the right arrow (>) cursor key as shown below.

The screenshot shows the 'Program Generation' software interface. At the top, there is a blue header bar with the text 'Program Generation'. Below the header, there are three tabs: 'Editor', 'VPS', and 'Shape Creator'. The 'VPS' tab is highlighted in orange. In the top right corner, there are two buttons: 'To Switch Boxes [F4]' and 'Load [ENTER]'. Below these buttons is a section titled 'Recently Used' containing a text box with the text 'PROBING/TOOL OFFSETS/TURNING TOOLS/Manual'. At the bottom of the interface, there is a 'Forward' button with a right-pointing arrow, followed by the text 'Search (TEXT) [F1], or [F1] to clear.' and an empty search input field. Below the search area is a section titled 'Current Directory:' followed by a table listing directories.

File Name	Size	Last Modified	
PROBING	<DIR>	08/28/18 11:32	>
VPS	<DIR>	08/28/18 11:33	>
CUSTOM	<DIR>	04/13/17 10:29	>



Then use the down cursor key to highlight the probing tab as shown below.

Forward  Search (TEXT) [F1], or [F1] to clear.

Current Directory:

File Name	Size	Last Modified	
PROBING	<DIR>	08/28/18 11:32	>
VPS	<DIR>	08/28/18 11:33	>
CUSTOM	<DIR>	04/13/17 10:29	>



Cursor to the right (>) to open the Tool Offsets tab

 Back Forward  Search (TEXT) [F1], or [F1] to clear.

Current Directory: PROBING/

File Name	Size	Last Modified	
TOOL OFFSETS	<DIR>	08/28/18 11:32	>

Cursor to the right (>) again to highlight the Turning Tools Tab.

 Back Forward  Search (TEXT) [F1], or [F1] to clear.

Current Directory: PROBING/TOOL OFFSETS/

File Name	Size	Last Modified	
TURNING TOOLS	<DIR>	08/28/18 11:32	>
LIVE TOOLS	<DIR>	08/28/18 11:32	>

Cursor to the right (>) again to highlight the Manual Tab.

Editor VPS Shape Creator

VPS

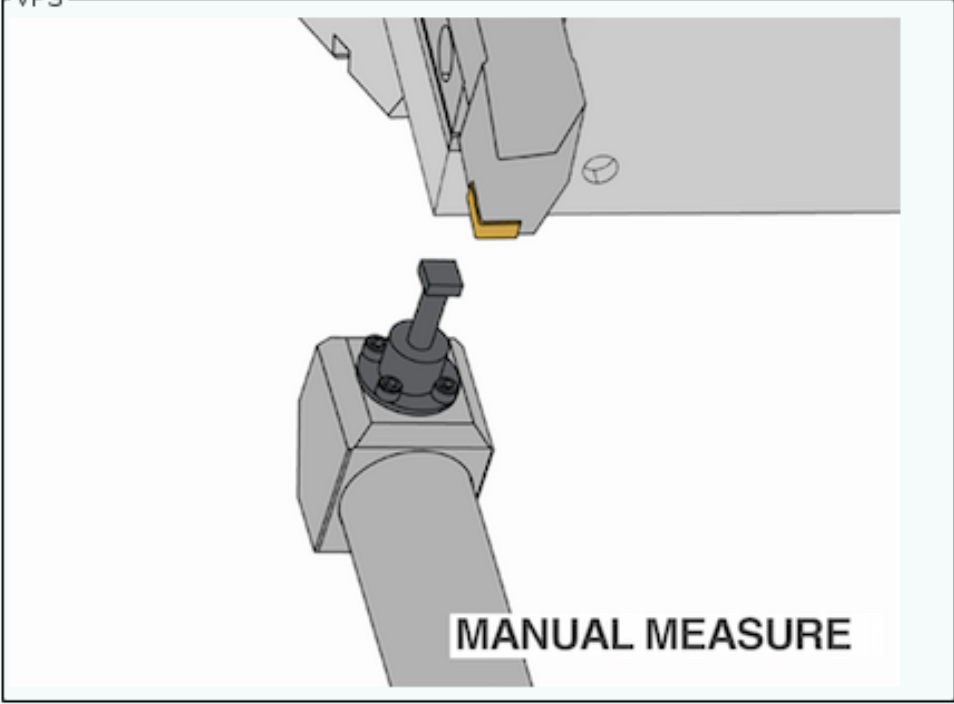

To Switch Boxes [F4]
Load [ENTER]

◀ Back Forward ▶ Search (TEXT) [F1], or [F1] to clear.

Current Directory: PROBING/TOOL OFFSETS/TURNING TOOLS/

File Name	Size	Last Modified
Manual	17513	08/28/18 11:32
Automatic	33236	08/28/18 11:32
Break Detection	33926	08/28/18 11:32

Program Generation

Editor VPS Shape Creator

Tool Probe Manual Mode

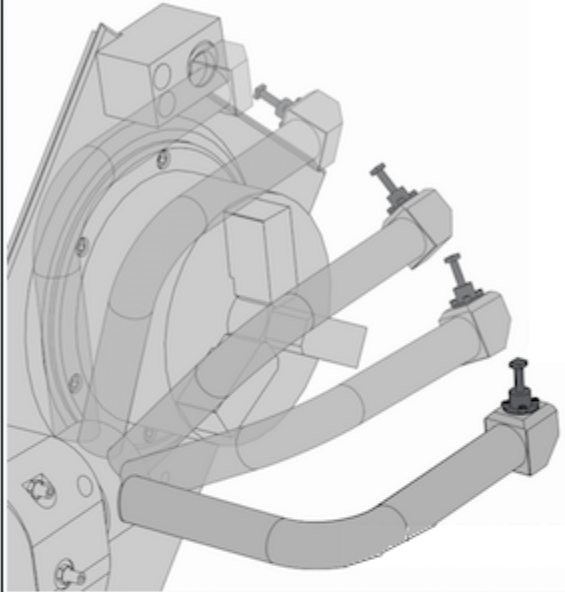

F2

Run in MDI [CYCLE START]

Generate Gcode [F4]

Reset [ORIGIN]

Devices [F2]

Jog Axis+ [HAND JOG]

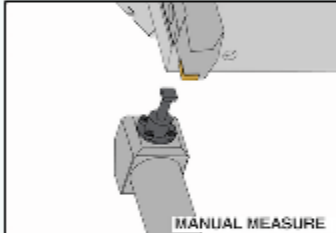

◀ Back

Variable	Value	Ranges
PRESS_[F2]_KEY		
TOOL_NUMBER	1	
TOOL_OFFSET_NUMBER	1	[1 - 99]
TOOL_TIP	0	[1 - 8]
TOOL_TIP_DIRECTION_0	0	
X_OFFSET	0.0	
Z_OFFSET	0.0	

Press [F2], select Probe Arm and press [F2] to EXTEND or RETRACT probe Arm

Pressing F2 will give the option to Extend the probe arm. Make sure it will clear the part and the turret before extending.

Cursor down to Tool number gives the following. It defaults to the current active tool.

Program Generation

Editor VPS Shape Creator

Tool Probe Manual Mode

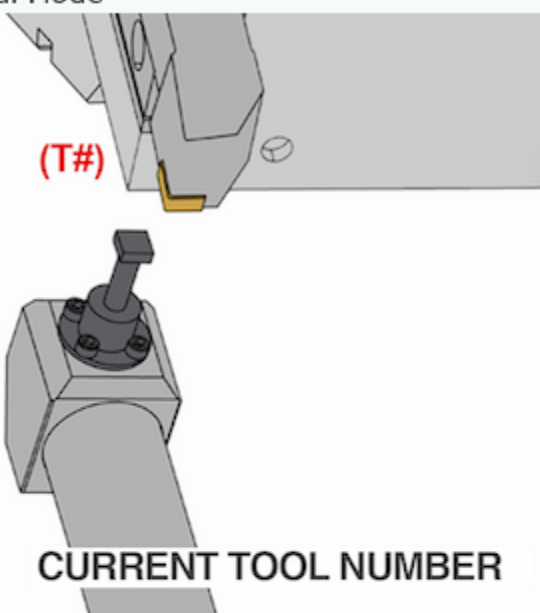

CURRENT TOOL NUMBER

Run in MDI [CYCLE START]

Generate Gcode [F4]

Reset [ORIGIN]

Devices [F2]

Jog Axis+ [HAND JOG]

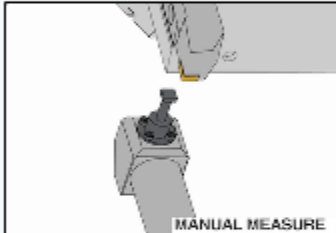

MANUAL MEASURE

Back

Variable	Value	Ranges
PRESS_[F2]_KEY		
TOOL_NUMBER	1	
TOOL_OFFSET_NUMBER	1	[1 - 99]
TOOL_TIP	0	[1 - 8]
TOOL_TIP_DIRECTION_0	0	
X_OFFSET	0.0	
Z_OFFSET	0.0	

DEFAULT is current active TOOL NUMBER. Index turret to desired tool to measure

Cursor down to the Tool Offset Number and enter it, normally the same as the Tool Number. Then cursor down to the Tool Tip Direction. If you are using a **turning tool** it will be **3**. If you are doing a **boring tool** it will be **2**. 4 and 1 would be used for back turning and back boring respectively. Not recommended unless you have the part securely clamped.

Program Generation

Editor VPS Shape Creator

Tool Probe Manual Mode

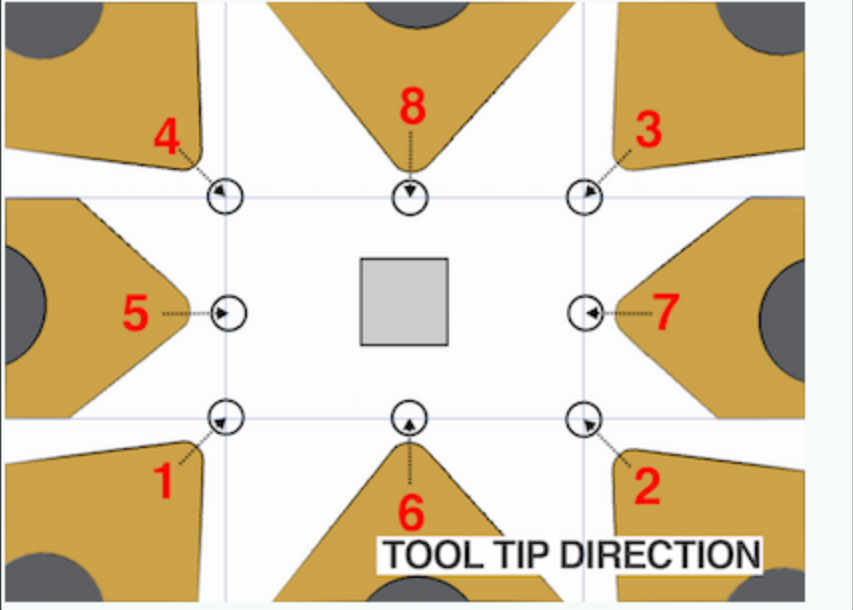
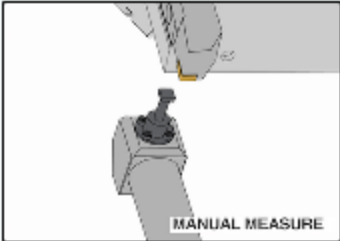
Run in MDI [CYCLE START]

Generate Gcode [F4]

Reset [ORIGIN]

Devices [F2]

Jog Axis+ [HAND JOG]

Back

Variable	Value	Ranges
PRESS_[F2]_KEY		
TOOL_NUMBER	1	
TOOL_OFFSET_NUMBER	1	[1 - 99]
TOOL_TIP	3	[1 - 8]
JOG_POSITION_3	Axis Letter + HANDLE JOG	
TOOL_TIP_DIRECTION_3	3	
X_OFFSET	0.0	
Z_OFFSET	0.0	

Select TOOL TIP direction. Tool Offsets Page will update once cycle is completed

After the correct tool type is selected a down cursor to jog position shows the correct placement of the tool before probing. This will depend on which tool tip type is selected.

Program Generation

Editor VPS Shape Creator

Tool Probe Manual Mode

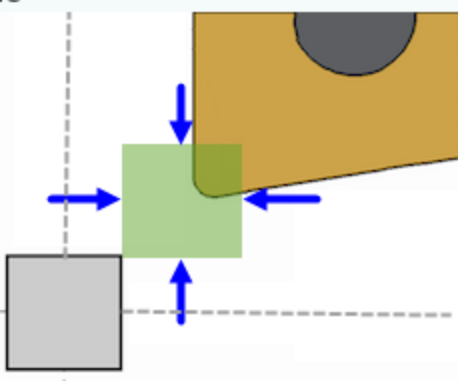

Run in MDI [CYCLE START]

Generate Gcode [F4]

Reset [ORIGIN]

Devices [F2]

Jog Axis+ [HAND JOG]

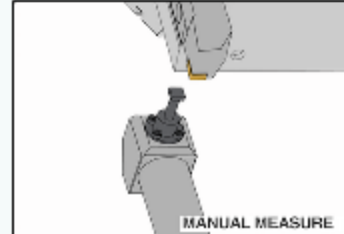

MANUAL MEASURE

X
HAND JOG

◀ Back

Variable	Value	Ranges
PRESS_[F2]_KEY		
TOOL_NUMBER	1	
TOOL_OFFSET_NUMBER	1	[1 - 99]
TOOL_TIP	3	[1 - 8]
JOG_POSITION_3	Axis Letter + HANDLE JOG	
TOOL_TIP_DIRECTION_3	3	
X_OFFSET	0.0	
Z_OFFSET	0.0	

Press AXIS Letter + HANDLE JOG key and jog tool tip within (.25"/6mm) of probe

Jog the tool to position shown. This can be done by enter axis (X or Z) on the input line then pressing [Hand Jog] key.

After jogging the tool to the correct position a cursor down to Tool Tip Direction shows the sequence and direction of the actual probing program when it is run.

Program Generation

Editor VPS Shape Creator

Tool Probe Manual Mode

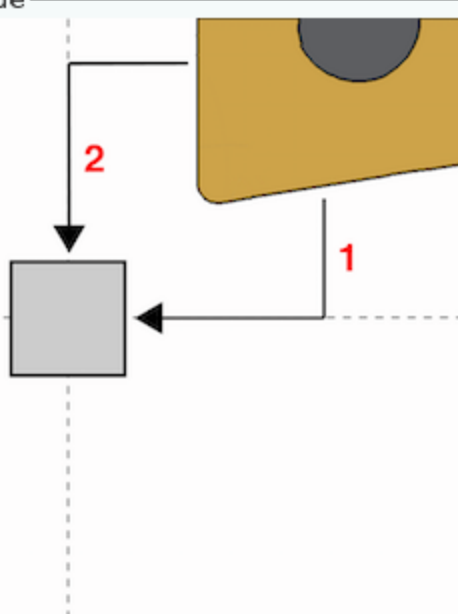

Run in MDI [CYCLE START]

Generate Gcode [F4]

Reset [ORIGIN]

Devices [F2]

Jog Axis+ [HAND JOG]

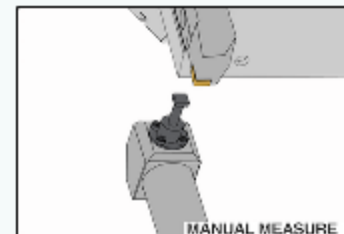

Back

Variable	Value	Ranges
PRESS_[F2]_KEY		
TOOL_NUMBER	1	
TOOL_OFFSET_NUMBER	1	[1 - 99]
TOOL_TIP	3	[1 - 8]
JOG_POSITION_3	Axis Letter + HANDLE JOG	
TOOL_TIP_DIRECTION_3	3	
X_OFFSET	0.0	
Z_OFFSET	0.0	

TOOL TIP (3) and probe sequence. Display only

The probing program can be run by depressing the Cycle Start Key.

Below shows the sequence of movement with using a type 2 tool such as a boring bar for ID work.

Program Generation

Editor VPS Shape Creator

Tool Probe Manual Mode

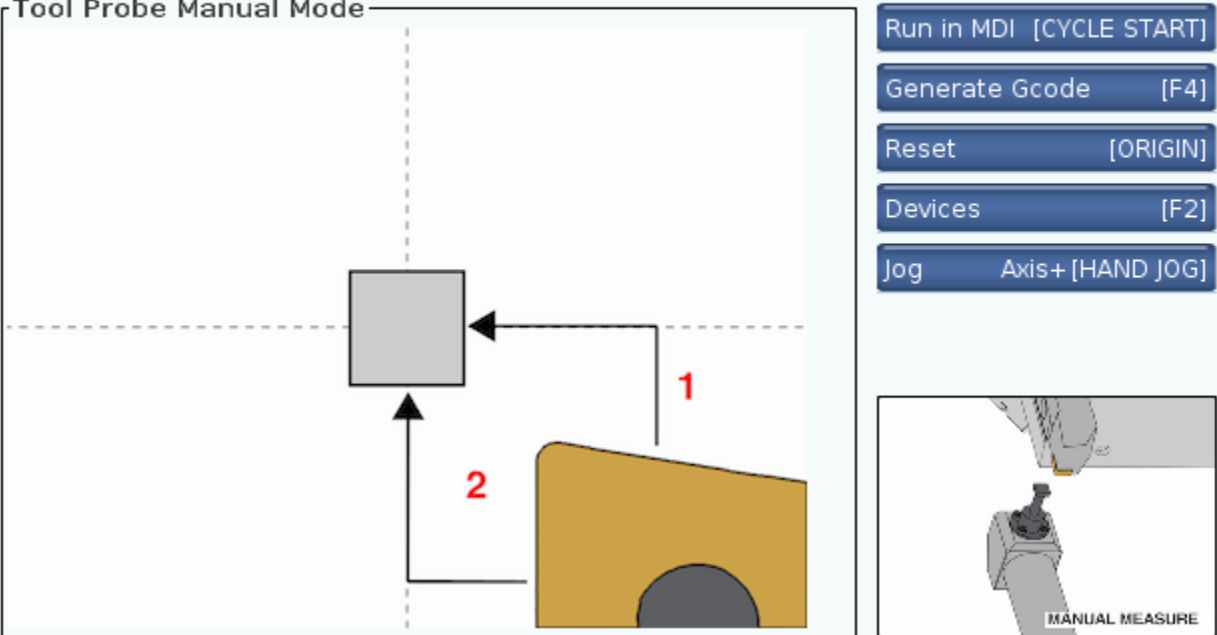

Run in MDI [CYCLE START]
 Generate Gcode [F4]
 Reset [ORIGIN]
 Devices [F2]
 Jog Axis+ [HAND JOG]

Back

Variable	Value	Ranges
PRESS_[F2]_KEY		
TOOL_NUMBER	1	
TOOL_OFFSET_NUMBER	1	[1 - 99]
TOOL_TIP	2	[1 - 8]
JOG_POSITION_2	Axis Letter + HANDLE JOG	
TOOL_TIP_DIRECTION_2	2	
X_OFFSET	0.0	
Z_OFFSET	0.0	

TOOL TIP (2) and probe sequence. Display only

Program Generation

Editor VPS Shape Creator

VPS

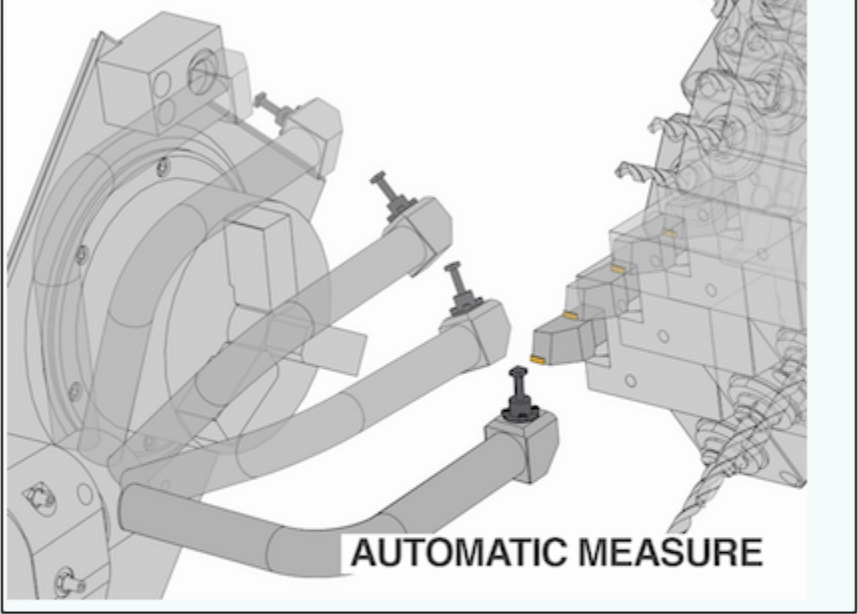

To Switch Boxes [F4]
Load [ENTER]

◀ Back Forward ▶ Search (TEXT) [F1], or [F1] to clear.

Current Directory: PROBING/TOOL OFFSETS/TURNING TOOLS/

File Name	Size	Last Modified
Manual	17513	08/28/18 11:32
Automatic	33236	08/28/18 11:32
Break Detection	33926	08/28/18 11:32

Automatic and Break Det. Modes can only be run for a tool if it has **first been set up using the Manual Mode**. The way the automatic and break detection modes work is the first the probe is extended. Then in rapid mode the machine indexes to the desired tool and then rapids up to the probe. If tools have been changed and not been first run in manual mode a crash may occur involving the probe.

Pressing enter will bring up below

Program Generation

Editor VPS Shape Creator

Tool Probe Automatic Mode

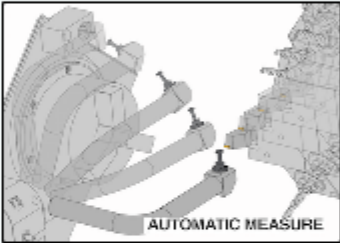
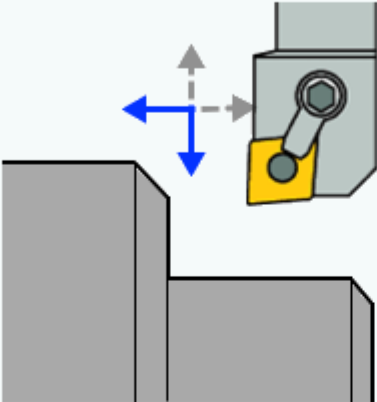

Run in MDI [CYCLE START]
Generate Gcode [F4]
Reset [ORIGIN]
Devices [F2]
Jog Axis+ [HAND JOG]

Back

Variable	Value	Ranges
TOOL_NUMBER	1	[1 - 12]
TOOL_OFFSET_NUMBER	1	[1 - 99]
CALIBRATION_DIRECTION_3	3	
TOOL_TYPE_OD_TURN	OD_TURN	
X_OFFSET	-10.0	
Z_OFFSET	-10.0	

TOOL TYPE display only. To change go to offsets page

Generate the code using F4 and place it in the clipboard.

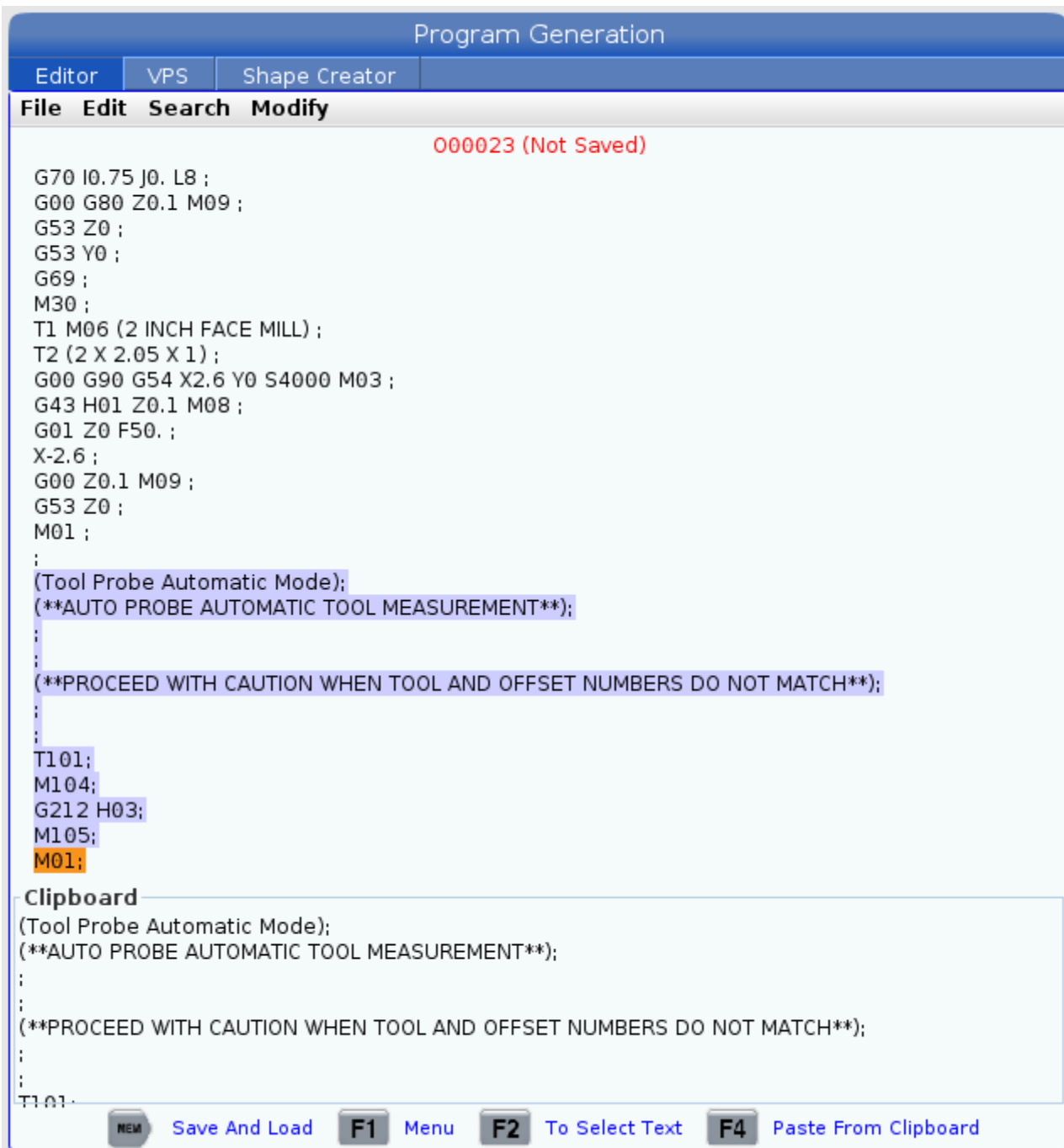

Then paste it in the location where it desired. The automatic mode the offsets after a part is run for a certain amount of time.

In a similar fashion break detection code may be used.

With both these automatic modes the tool must first be set using the manual mode.

Settings

Scrolling through Settings with Jog Handle - The jog handle can now be used to scroll through the settings. In previous versions, the jog handle could only be used to scroll through (cursor-highlight) the parameters, but not the settings. This has been corrected. (Any Mill Control Ver. 10.15 and above; any Lathe Control Ver. 3.05 and above.)

There are many settings which give the user various options over the control of their machine tool. Read the Settings section of the operator's manual for all the possible options. Here are some of the more useful settings.

- Setting 1** **AUTO POWER OFF** – This turns the machine off after it is idle for the number of minutes defined in this setting.
- Setting 2** **POWER OFF AT M30** – This option will power off the machine tool when an M30 command is executed. In addition, for safety reasons, the control will turn itself off if an overvoltage or overheat condition is detected for longer than four minutes.
- Setting 8** **PROG MEMORY LOCK** – When this is **Off**, control program memory can be modified. When this setting is turned **On**, memory edits cannot be done and programs cannot be erased.
- Setting 9** **DIMENSIONING** – This changes the machine control from inch to metric, which will change all offset values and position displays accordingly. This setting *will not* change your program to either inch or metric.
- Setting 31** **RESET PROGRAM POINTER** – When this is On, the **RESET** key will send the cursor (program pointer) back to the beginning of the program. Normally set to on.
- Setting 32** **COOLANT OVERRIDE** – This setting controls how the coolant pump operates. The settings are: Normal, Ignore and Off. When it is set on Normal, coolant commands respond as programmed. If set on Ignore, an M08 or M88 command in the program will not turn the coolant on (i.e., the command will be ignored), but it can be turned on manually using the **COOLNT** key. If this setting is Off, the coolant cannot be turned on at all, and the control will give an alarm when it reads an M08 or M88 command in a program.
- Setting 33** **COORDINATE SYSTEM** – This setting changes the way the G92/G52 offset system works. It can be set to Fanuc, or Yasnac. Normally it is set to Fanuc.

- Setting 36** **PROGRAM RESTART** – When it is OFF, starting a program from anywhere other than the beginning of a program or a tool sequence may produce inconsistent results or crashes. When it is ON, you are able to start a program from the middle of a tool sequence. You cursor onto the line you want to start on and press CYCLE START. It will cause the entire program to be scanned to ensure that the correct tools, offsets, G codes, and axes positions are set correctly before starting and continuing at the block where the cursor is positioned. Some alarm conditions are not detected prior to motion starting. You could leave this setting ON all the time if you want, but it might do some things unnecessarily, so you would probably prefer to turn it OFF when you're done using it.
- Setting 42** **M00 AFTER TOOL CHANGE** – When off tool changes are normal. When **ON** a program stop (M)) will occur after a tool index. **M00 FOUND** will be displayed at the bottom left.
- Setting 51** **DOOR HOLD OVERRIDE** – This setting is **no longer available** to use in new machines. On older machine when it is off, a program cannot be started if the doors are open, and opening the doors will cause a running program to stop – just like a feed hold. When this setting is On, the door condition is ignored. This setting will always be Off when the control is powered up.
- Setting 56** **M30 RESTORES DEFAULT** – When this setting is on pressing the **Reset** key or a M30 will restore all defaults.
- Setting 76** **FOOT PEDAL LOCK OUT** – When set to Off the foot pedal operates normally. When ON the foot pedal is ignored by the control.
- Setting 84** **TOOL OVERLOAD ACTION** – This is used to determine tool overload conditions as defined by the Tool Load monitor page in the CURNT COMDS display (use **PAGE DOWN** to get there). A tool overload condition can result in one of four actions by the control, depending on Setting 84. ALARM will generate an alarm when overload occurs; FEED HOLD will stop with a Feed Hold when overload occurs; BEEP will sound an audible alarm when overload occurs; or AUTOFEED will automatically decrease the feed rate.
- Setting 85** **MAX CORNER ROUNDING** – This setting is used to set the corner rounding accuracy required by the user. The accuracy defined in Setting 85 will be maintained even at maximum feed rate. The control will only slow at corners *when it is needed*. If it is set at 0 the machine will operate in the exact stop mode, slowing speed of machine.
- Setting 88** **RESET RESETS OVERRIDE** – When this is On, the RESET key sets all overrides back to 100%.
- Setting 92** **CHUCK CLAMPING** – Specifies **OD** (outside diameter) or **ID** (inside diameter clamping).

- Setting 93** **TAIL STOCK X CLEARANCE**– Works in conjunction with setting 94. Defines X axis travel limit for turret so it won't crash into tail stock. When jogging no alarm is generated.
- Setting 94** **TAIL STOCK Z CLEARANCE**– Works in conjunction with setting 94. Defines Z axis travel limit for turret so it won't crash into tail stock. When jogging no alarm is generated.
- Setting 101** **FEED OVERRIDE > RAPID** – When this setting is OFF, the machine will behave normally. When it is ON and HANDLE CONTROL FEED RATE is active, the jog handle will affect both the feed rate override and the rapid rate override simultaneously. That is, changing the feed rate override will cause a proportional change to the rapid rate. The maximum rapid rate will be maintained at 100% or 50% according to setting 10. (Any Mill Control Ver. 10.22 and above; any Lathe Control Ver. 4.11 and above.)
- Setting 103** **CYC START/FH HUCK CLAMPING** – When **ON** cycle start must be presses and held in to run a program. When **CYCLE START** key is released machine goes into a feed hold. When OFF the machine operates normal.
- Setting 104** **JOG HANDLE TO SNGLBLK** When this is **ON** and **SHGLBLK** is selected, the jog handle can be used to single step through a program.
- Setting 103** **CYC START / FH SAME KEY** – When this setting is ON, the CYCLE START button functions as the Feed Hold key as well. When CYCLE START is pressed and held in, the machine will run through the program; when it's released, the machine will stop in a Feed Hold. This gives you much better control when testing a new program. When you are done using this feature, turn it Off. This setting can be changed while running a program. It cannot be ON when Setting 104 is ON. When one of them is turned ON, the other will automatically turn OFF. (Any Mill Control Ver. 9.06 and above; any Lathe Control Ver. 4.11 and above.)
- Setting 104** **JOG HANDL TO SNGL BLK** – When running a program in MEM mode in the Program or Graphics display, you can use the SINGLE BLOCK key to cycle through your program one line at a time with each press of the CYCLE START button, when the machine is running or you are in Graphics. If you turn Setting 104 ON, and SINGLE BLOCK has been selected. You first press the CYCLE START button, then each counterclockwise click of the jog handle will step you through a program line by line. Turning the handle clockwise will cause a FEED HOLD. This setting can be changed while running a program. It cannot be ON when Setting 103 is ON. When one of them is turned ON, the other will automatically turn OFF. (Any Mill Control Ver. 9.06 and above; any Lathe Control Ver. 4.11 and above.)

Setting 114 CONVEYOR CYCLE (MIN) – If this is set to zero, the conveyor will operate normally. If another number is entered, it defines how long (in minutes) each cycle will be when the chip conveyor is turned on. The chip conveyor cycle is started with either an M code (M31 or M32) or with the control **CHIP FWD/REV** keys. It will stay on for the time defined in Setting 115, then turn off and not restart until the cycle time in Setting 114 has elapsed.

Setting 115 CONVEYOR ON TIME (MIN) – This setting works with Setting 114, which defines the conveyor cycle time. Setting 115 defines how long the chip conveyor will stay on during each cycle.

Setting 163 Disable 0.1 Jog Rate – This disables the .10 jog rate key. With this disabled, the fastest job rate will be .01 in/min. With a jog rate of .10 in/min it is easy to go past the intended location and possibly result in a crash.

Hydraulic Tailstock Operation

The optional Haas Hydraulic Tailstock is a hydraulically actuated cast iron member which runs along two linear guides. The 20 inches of travel allows a long part to be machined. Tailstock motion is controlled in one of three ways:

1. Through program code.
2. In jog mode.
3. By a foot switch.

The tailstock is designed to travel to position at two rates:

1. High pressure is called “rapid” and can be programmed with G0.
2. Low pressure is called “feed” and can be programmed with G1. It is used to hold the part. An F code is required for feed mode (even if previously invoked) but it does not affect the actual feed rate.

CAUTION!!

1. Recommended minimum tailstock operating pressure is 120 psi. Pressure below 120 psi may result in unreliable operation.
2. If Settings 93 and 94 are not used. There is **NO RESTRICTED ZONE** for the tailstock. The turret and tailstock can be crashed together if improperly operated.
3. It is important to verify tailstock and turret clearance before operating machine or serious damage could occur. Settings 93 and 94 are set at the factory but with tools sticking out these must be reset to prevent collisions.
4. FEED HOLD will NOT stop the hydraulic tailstock.

Jogging

- In JOG mode, the keys “TS ←” AND “TS →” are used to jog the tailstock at low pressure (feed).
- The jog handle cannot be used to jog the tailstock.
- By pressing TS ← and TS → keys together with TS RAPID high pressure (rapid) is selected.
- When tailstock keys are released, the control reverts to the last jogged axis, X or Z.

Run Time Alarms

If a part is being held and tailstock motion is detected, Alarm (394/317) B AXIS OVERTRAVEL is generated. This will stop the program and turn off the spindle.

Diagnostic Displays

OUTPUTS:	TSFAST 0	=	low pressure
	1	=	high pressure
	TS → 1	=	tailstock away from chuck, + direction
	TS ← 1	=	tailstock toward chuck, - direction
INPUTS:	TS FWS	=	foot pedal input

Hydraulic Pressure

The following information can also be found on the side panel of the machine:

**RECOMMENDED HYDRAULIC TAILSTOCK OPERATING PRESSURE IS 120 PSI.
OPERATING PRESSURES BELOW 120 PSI MAY CAUSE THE TAILSTOCK TO FUNCTION
UNRELIABLY.**

Settings

105 TS RETRACT DISTANCE

The distance from the HOLD POINT (Setting 107) the tailstock will retract when commanded. This setting should be a positive value. 3.0 is a good starting value.

106 TS ADVANCE DISTANCE

When the tailstock is moving toward the HOLD POINT (Setting 107), this is the point where it will stop its rapid movement and begin a feed. This setting should be a positive value. 2.0 is a good starting value.

NOTE: If the values in Settings 105 and 106 are zero, the tailstock may not function as desired.

107 TS HOLD POINT (absolute machine coordinates)

Point to advance to for holding when **M21** is invoked. Usually this is inside of a part being held. It is determined by jogging to the part and adding some amount to the absolute position. This setting should be a negative value.

Automatic Tool Setting Probe Calibration Procedure

Tools needed for calibration

- O.D. turning tool
- 1 piece of stock that will fit in chuck jaws
- 0-1.0" Micrometer used to measure LTP stylus
- Micrometer to inspect stock diameter

If you have a manual tool probe (LTP) skip to the calibration procedure below. If you have an automatic tool probe (ATP), Verify the ATP arm operates correctly;

Select MDI/DNC then key in M104; M105; and press insert.

In Single Block mode, press Cycle Start button to run M104 to bring probe down.

Press Cycle Start button to run M105 to bring the probe arm back up.

Calibration Procedure

- 1) Install an O.D. turning tool in station one of the turret and clamp a piece of material in the chuck.
- 2) Select OFFSET and clear the offset values for tool #1 in the Tool Geometry page
- 3) Use tool #1 and take a skim cut on the test cut material. Do not jog the X-Axis away from the cut diameter. Move the tool away from the stock by jogging in the Z+ direction.
- 4) Stop the spindle and use a micrometer to measure the diameter. Record cut diameter here _____.
- 5) Highlight X-Axis offset for tool #1 on the Tool Geometry page. Then press the X DIA. MEAS button and enter the measured diameter from above. Record the offset here as a positive number X _____ (Offset A).
- 6) Change the value of settings #59 thru #63 to zero.
- 7) Jog the tool away to a safe position, key in M104 in MDI mode, and press cycle start to bring the probe to the down position. With manual LTP, pull the tool arm to the down position.
- 8) Using the hand wheel, jog the Z-Axis so the tip of tool #1 is approximately centered on the probe in the Z-Axis. Jog the X-Axis until the tip is about .04" (1mm) above the probe in the X-Axis.
- 9) Select .001 jog increment and press -X button until probe sounds off and stops the tool. Record the offset here as a positive number X _____ (Offset B).
- 10) Subtract Offset B from Offset A and Record the value here _____. Enter this value into Setting #59.
- 11) We will skip setting #60 until step 14 below.
- 12) Enter zero as the value for setting #61.
- 13) Use a Micrometer to measure the probe width and record the value here _____. Enter this value for setting #62 and #63 as a positive number.
- 14) Multiply the probe width by two. Enter that number here _____. Now, take that value and subtract it from Setting #59. This is the number that you will enter into setting #60 _____ as a positive number.
- 15) The Lathe Tool Probe is now calibrated.

Tool Room Lathe Orientation and Walk Around

The agenda for this section of the training manual is to familiarize everyone with the physical layout of the TL series machine, the functions of the mechanical features of the machine, and general maintenance of the TL series lathe.

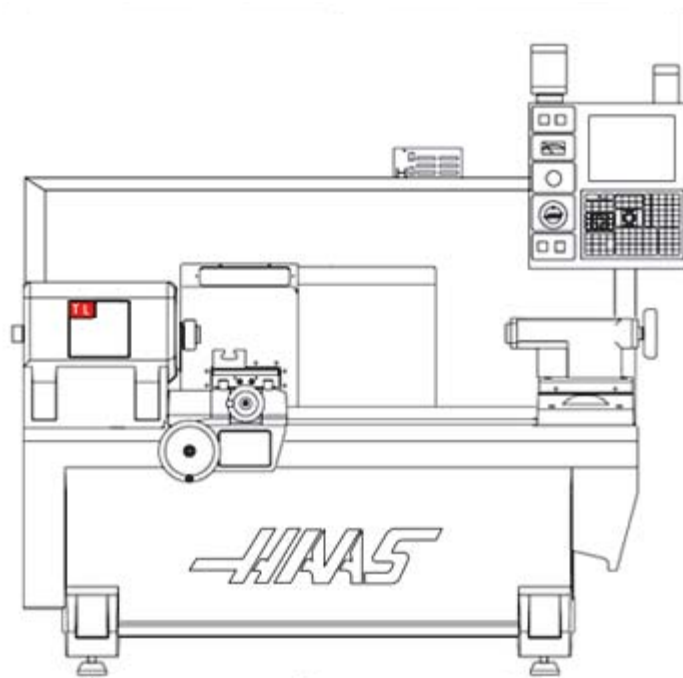

FRONT VIEW OF TL-SERIES LATHE (OLD STYLE)

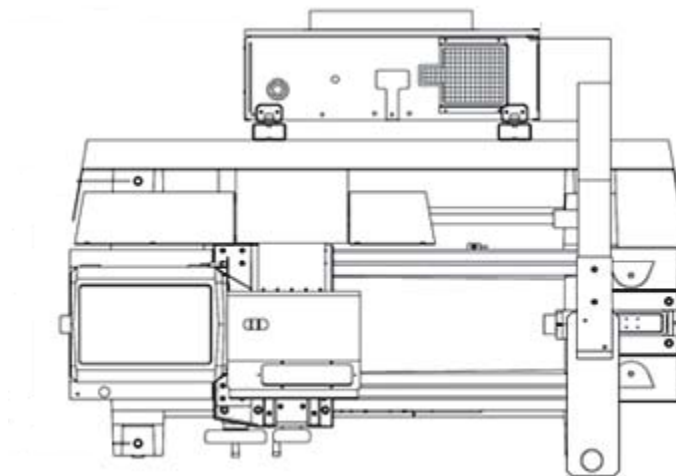

TOP-DOWN VIEW OF TL-SERIES LATHE (OLD STYLE)

Front View of TL-2* Lathe (NEW STYLE)

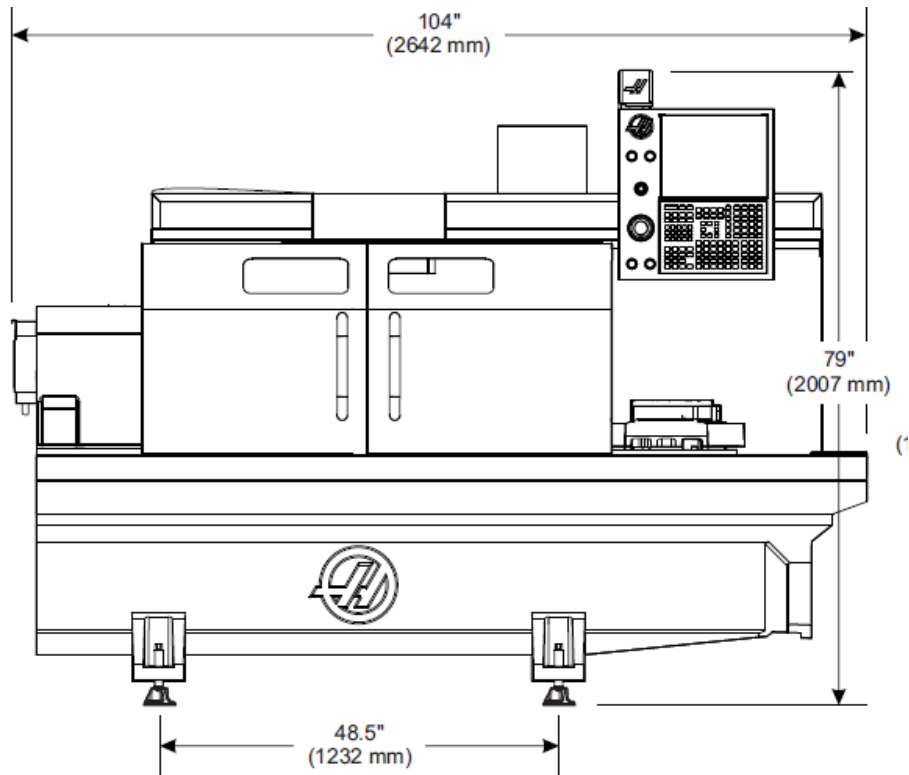

Top Down View TL-2* (NEW STYLE)

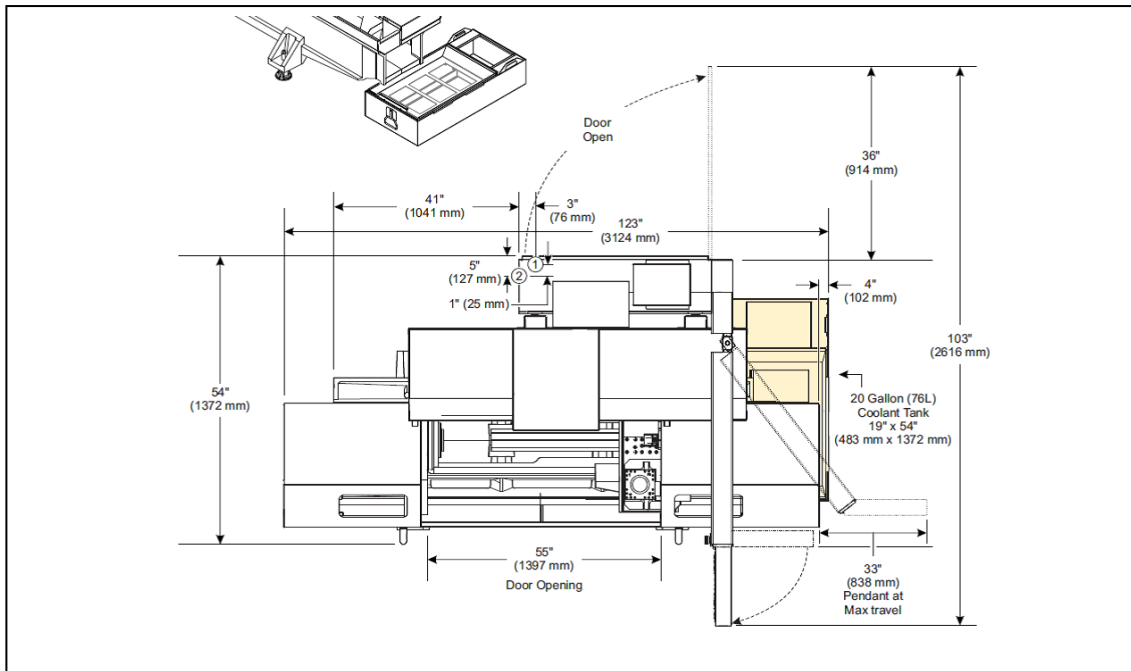

***NOTE: Dimensions**

will vary by model

Power-Up Procedures

The TL Series lathe follows the same standard start-up procedures as with any other Haas machine, and should be followed in the procedure demonstrated below:

Main Power

1. Locate the main power switch on the back of the machine's control cabinet, and switch it to the "ON" position.

Power-Up Procedure

After switching the main power supply on, we need to "power-up" the Haas control. That procedure is as follows:

1. Move the tailstock (if equipped) all the way to the far right of the limits of the machine, and leave the clamps on the tailstock loose. This will provide the saddle enough room to reference itself. ***CAUTION: the control does not know where the tailstock is, and there is a chance to crash if the tailstock is not in the home position!***
2. Visually verify that all of the machine's ways are clean and free of dirt, and any moving parts of the machine are clear of chips, coolant, etc... and verify that there is sufficient air pressure (80 psi) to the machine
3. Press the Green **POWER ON** button located on the upper left corner of the Haas control. The machine will take a couple of minutes to load its software.
4. The machine is now "Powered-On"

Machine Restart / Zero Return Procedure

After the control is powered on, we still need to “reference” the machine. Upon start-up, the control does not know the location of the cross slide (X axis) or the saddle (Z axis), so the machine needs to “find” these 2 axis thru a procedure known as a “Zero Return”. This will travel the machine to it’s farthest most limits so that the cross slide and saddle can be detected by the limit switches. If the emergency stop is engaged turn the button clockwise to release it.



Locate the orange RESET key and push it to clear any alarms that are present, and to power on the servos of the machine.

Next to the RESET button is the POWER UP key. After the POWER UP KEY is pressed the following pop up appears.

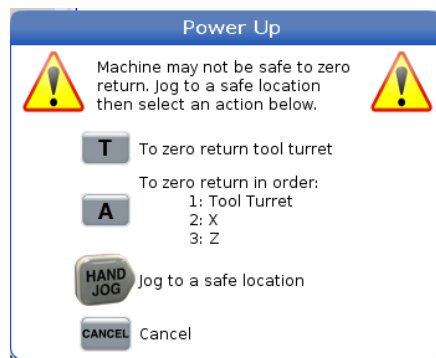

1. Press it once and the machine will travel the X axis first, then the Z axis to their utmost farthest limits, which is all the way towards the operator on the X axis / cross-slide, and all the way to the right for the Z axis / saddle. The machine will stop at machine home, as described in section-4.a.iii

Lathe Safety

Emergency Stop Switch

Located on the left side of the control panel, there is a large, round, red button that is circled with a yellow ring. This is the EMERGENCY STOP or “E-STOP” button. In the event of an un-controlled machine condition, a crash of the machine, or any situation that requires an immediate shut down of all axis functions, movement, spindle functions and power to the servos of the machine, the Emergency Stop button should be used. This button is used to halt everything on the machine immediately!

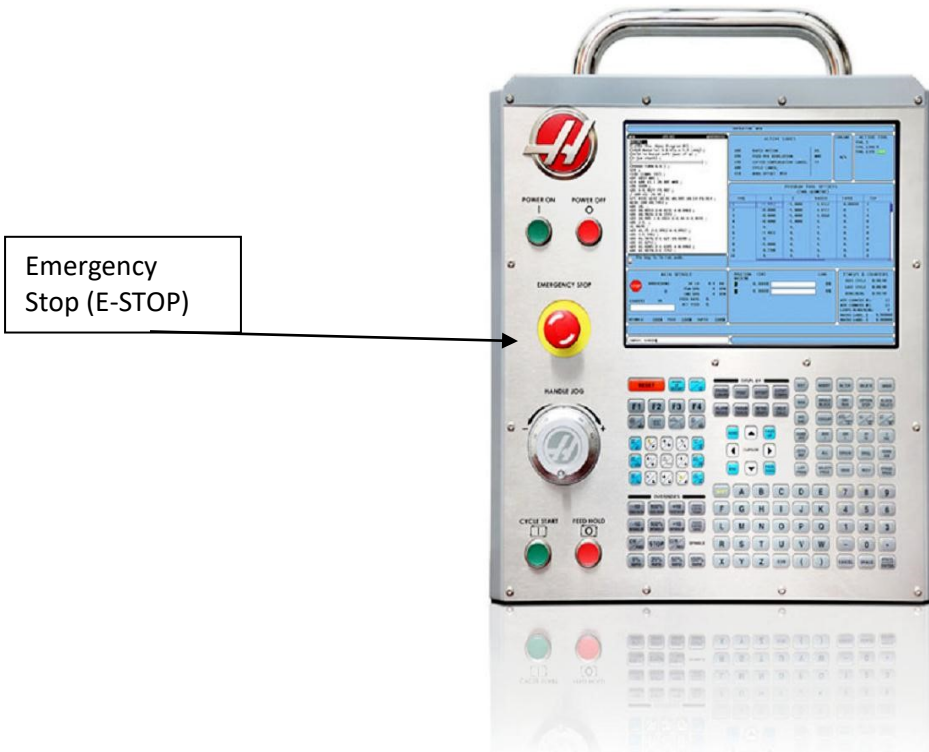

Proper Use of Machine Guarding

The Toolroom Series of lathes comes equipped as a “closed” machine, much like that of a turret lathe. The hand wheels, chuck, tailstock and tool post are all exposed when the door is open. Extreme concern should be used when the machine is moving in ANY mode of operation, but especially in CNC mode. The spindle may be turning, and it is possible for loose clothing, hair, etc.... to get caught within the moving parts of the machine.

Also, extreme care should be taken when around the chuck and part as it turns. The main motor of the machine has a large amount of power, and can be dangerous. Extreme care should be taken to avoid a collision between any tooling or the tool-post and the chuck. It is possible to do exactly that.

All TL series machines come either equipped with a complete set of sheet metal that encloses the machine and the machine should not be run with doors open.

In the current version of the TL series of software, it is impossible to run in either manual or CNC modes with the door open. The setting on the control may be changed, but changing this setting rests all responsibility on the operator and or the owners of the machine. Neither Haas, Productivity, nor any individuals of either company can be responsible for bypassing ANY safety settings on the machine.

Maintenance of the TL Series Lathe

Even though your TL Series machine has been built to the highest standards, using the highest available techniques and materials, general maintenance is required on both the machine and on the control to insure long life of its components.

Haas has gone thru extensive testing to verify the specifications on the required lubricants and filters that went into your new machine before they ever entered Haas's production, please use parts, filters, and lubricants that are as specified to insure longevity of the life of your or your boss's investment. This will maintain the highest levels of performance and accuracies for the longest possible time.

If there is any question on what exactly to use, please refer to the Operator's Manual for these specifications or contact the Productivity Service and Parts Department for the proper fluids and parts required for maintenance.

Productivity, Inc. - Service and Parts



Haas Factory Outlet

A Division of Productivity, Inc.

www.productivity.com

MN – 15150 – 25th Avenue North, Plymouth, MN 55447

Ph 763-476-8600 Fax 763-476-4092

IA – 9440 Atlantic Drive SW, Cedar Rapids, IA 52404

Ph 319-734-3403 Fax 319-632-4289

NE – 8402 South 117th Street, Omaha, NE 68128

Ph 402-330-2323 Fax 402-330-6901

Headstock Lubricant

The headstock or spindle of the TL series machine is a grease-pack design, and will not require any regular maintenance.

Grease Points

The TL series lathes are equipped with grease fittings rather than an oil lube system to provide surface to surface lubrication for all contact points on the machine. The linear ways, the ball screws, and the tailstock are all equipped with grease fittings, and they should be lubricated weekly to insure consistent performance and accuracy of your machine. Chuck should be greased daily.

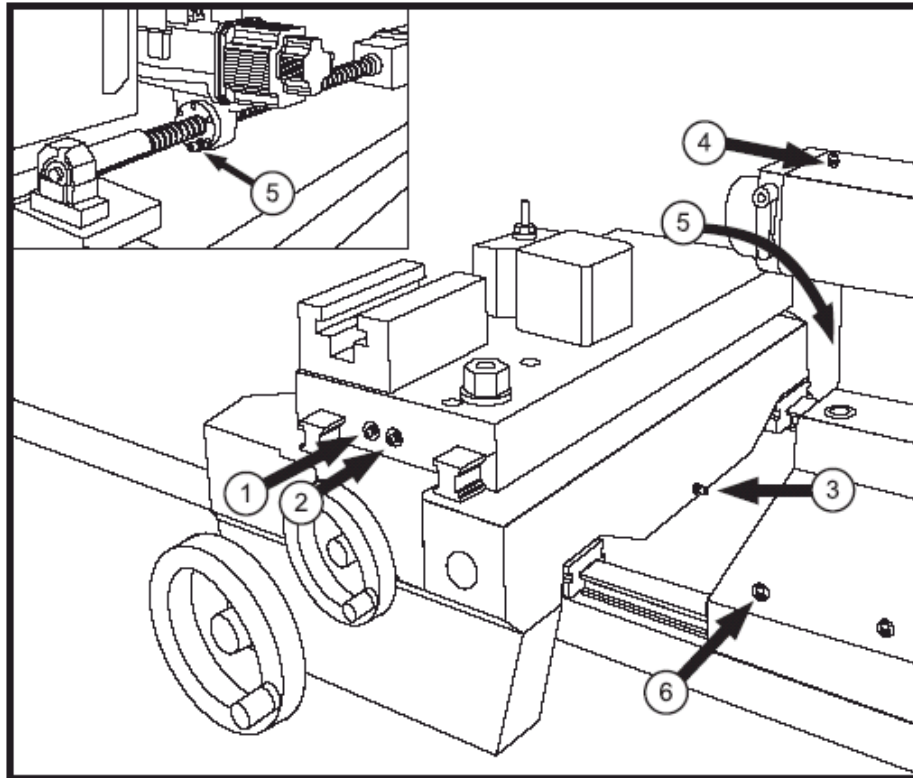

TL Series Lubrication Points

1. X-axis cross-slide trucks
2. X-axis cross-slide ball screw
3. Z-axis saddle trucks
4. Tail-stock screw
5. Z-axis saddle ball screw (Not accessible on newer models)
Grease not required.
6. Tailstock base; four places

For the lubrication points shown above, a general purpose lithium grease is required with enough volume to push grease out from the front and back of the linear ways, and from around the ball screw bearing housings

Aloris Tool Post Operation

The most often equipped option for the TL series lathe for holding your turning tools is the Aloris Single Station Tool Post option. This system allows for setting individual tools in their own respective holders, and allows for a repeating, quick change system, that has extensive options to allow for safe holding of a wide variety of different tooling products.

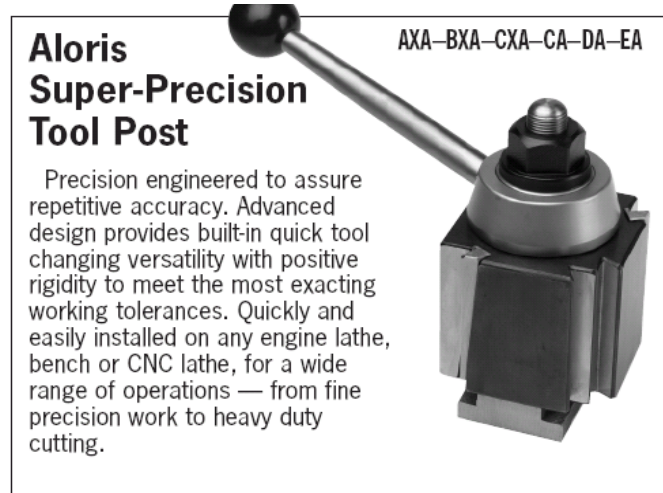

Aloris Super-Precision Tool Post

All that is required of the operator to switch from one tool to the next, is to swing the handle in a counter-clockwise direction to release the current tool, pull the tool-holder up and off of the Aloris dovetail, slide on the next tool onto the Aloris dovetail, and swing the lever till clockwise to firmly clamp the tool-holder against the tool post.

CAUTION: Please take care to never change tools while the machine has the spindle turning or while the axis are moving!!

3 Jaw Scroll Jaw Chuck Operation

The standard Haas option for the TL series lathe for part holding is a 3-jaw scroll plate chuck, that is key operated from the outer diameter of the chuck. Simply rotate the chuck key in a clockwise direction to draw the jaws of the chuck closer to the chuck center, and counter-clockwise to move the jaws away from the chuck center. The configuration of the chuck jaws and part holding is up to the operator to decide which is best for that particular project.

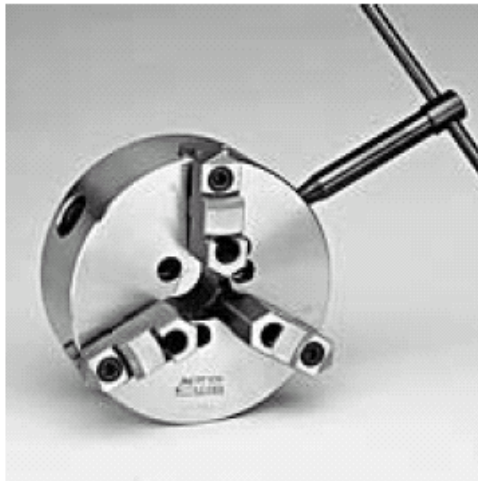

3-Jaw Scroll Chuck / Key

CAUTION: The chuck key comes equipped with a spring on the end to prevent accidentally starting the spindle with the chuck key engaged to the chuck. DO NOT REMOVE THE SPRING FROM THE KEY!!!! Starting the spindle with the chuck key engaged will lead to extensive machine damage and potential physical harm for the operator!

HAAS Visual Programming System (VPS)

The most outstanding feature on the TL Series of Haas machines is the Visual Programming System, or VPS. This is a simplified programming system that allows for much faster programming and setup of the machine and allows the operator to program using a question and answer format, rather than a G&M code format.

The objective of this section is to go thru the different VPS “Tabs” and “Menus” and how each relates to generating fast and accurate parts from the TL Series Lathe.

To navigate to the VPS 1st press the Edit to get to the Editor as shown below.

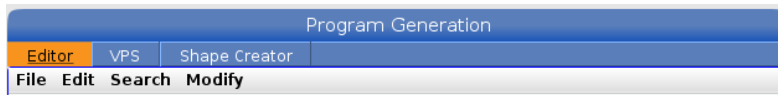

Next arrow over to the VPS.

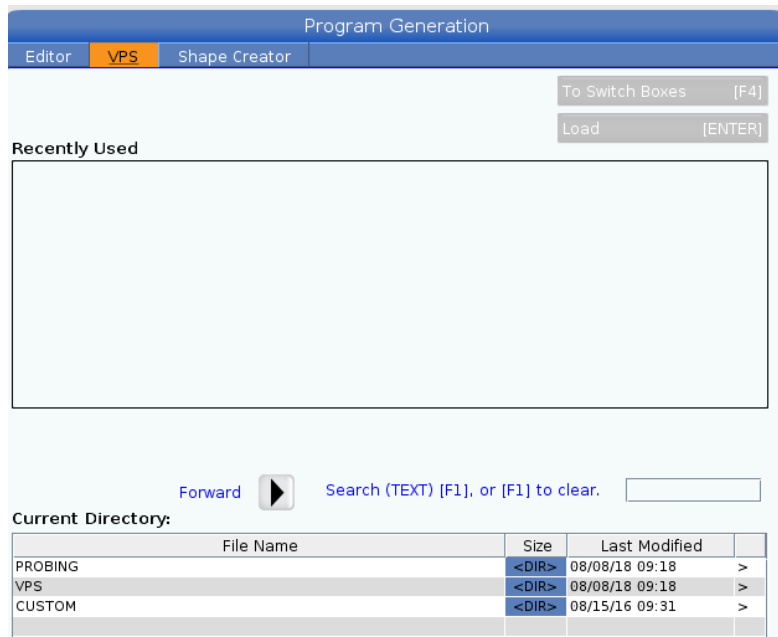

Next press the down arrow key twice to highlight the VPS as below.

Current Directory:

File Name	Size	Last Modified	
PROBING	<DIR>	08/08/18 09:18	>
VPS	<DIR>	08/08/18 09:18	>
CUSTOM	<DIR>	08/15/16 09:31	>

Pressing the right arrow key (>) will bring up the directory for the Visual Programming System Shown below:

Program Generation

Editor VPS Shape Creator

VPS

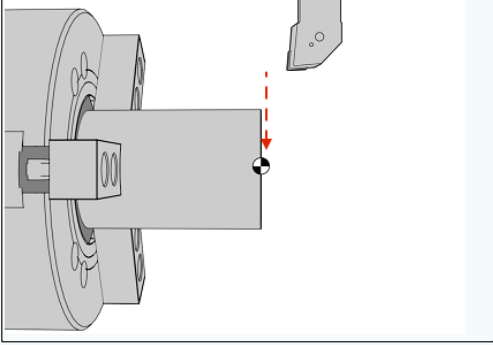

To Switch Boxes [F4]

Load [ENTER]

◀ Back Forward ▶ Search (TEXT) [F1], or [F1] to clear.

Current Directory: VPS/

File Name	Size	Last Modified	
Face Turn	35949	08/08/18 09:18	
OD Turn	54709	08/08/18 09:18	
ID Turn	54900	08/08/18 09:18	
OD Thread	48054	08/08/18 09:18	
ID Thread	47329	08/08/18 09:18	
Drilling	28345	08/08/18 09:18	
OD Groove	109935	08/08/18 09:18	
ID Groove	110114	08/08/18 09:18	
OD Radius	54998	08/08/18 09:18	
ID Radius	55027	08/08/18 09:18	
OD Chamfer	67503	08/08/18 09:18	
ID Chamfer	67668	08/08/18 09:18	
Part Off	56334	08/08/18 09:18	

Using the UP/DOWN cursor keys will navigate you thru each different operation. Below the Face and Turn menu is highlighted and called up by pressing Enter key .

Variable	Value	Ranges
TOOL_NUMBER	1	[1 - 8]
TOOL_OFFSET_NUMBER	1	[1 - 99]
WORK_OFFSET_NUMBER	54	[54 - 59]
MAXIMUM_SPINDLE_RPM	1800	[1 - 3000.0]
SURFACE_SPEED_MINUTE	500	[50 - 2000]
X_RAPID_APPROACH	0.2	[0.05 - 5.0]
FLOOD_COOLANT	8	8 9
HPC_COOLANT	89	88 89
OD_DIAMETER	2.0	[0.0 - 9.6]
FINISH_DIAMETER	-0.1	[-0.25 - 2.0]
FACE_STOCK	0.02	[0.0 - 34.0]

Enter the OUTSIDE DIAMETER size

Enter appropriate values for a particular part. Note on the right are values the VPS will accept. In this operation the tool will establish the face of the part taking off .02" off the end. To create the code press F4. The following pop u will appear.

Program

- 1: Insert to Clipboard
- 2: Output to MDI
- 3: Create New Program

Exit [CANCEL]

3 is keyed in to select Created New Program

Create New Program

O Number (number required)

File Name

File comment

Enter [ENTER] Exit [UNDO]

O number is keyed in with TL Manual to be seen in parentheses.
 Pressing Enter will create the program.

The program must then be selected from the Memory directory and placed into the Active Memory as shown below.

Operation: MEM 14:08:59

MEM Memory/O00555.nc N8622

O00555 (TL MANUAL);
 (FACING CYCLE);
 (SAFETY LINE BELOW);
 G00 G54 G18 G40 G80 G97 G99;
 (TOOL = 1 / OFFSET = 1);
 (WORK OFFSET = 54);
 (MAXIMUM SPINDLE RPM = 1800);
 (CONSTANT SURFACE SPEED = 500);
 (OUTSIDE DIAMETER: 2.0);
 (FINISH DIAMETER: -0.1);
 (STOCK TO REMOVE = 0.02);
 (DEPTH PER PASS = .02);
 T101;
 G54;
 G50 S1800;
 G97 S720 M03;
 G00 Z0.22;
 G00 X2.4;
 M08;
 G96 S500;
 G00 Z0.02;
 G72 P8662 Q8663 D0.02 U0. W0. F0.01;
 N8662 G00 Z0.;
 G01 X-0.1;
 N8663 G00 Z0.02;
 G00 G80 Z0.22;
 G97 S720;
 M09;

List Programs

Memory User Data USB

Search (TEXT) [F1], or [F1] to clear.

Current Directory: Memory/

O #	Comment	File Name	Size	Last Modified
<input type="checkbox"/>	00020 (TESTDRILL)	TESTDRILL...	11 KB	04-16-2018 11:30
<input type="checkbox"/>	00022	O00022.nc	105 B	04-16-2018 10:42
<input type="checkbox"/>	00023 (2X2X1 CLASS ...)	O00023.nc	6 KB	01-16-2018 14:37
<input type="checkbox"/>	00025	O00025.nc	18 B	01-18-2018 14:27
<input type="checkbox"/>	00033 (CIRC INT WITH ...)	O00033.nc	392 B	06-11-2018 15:09
<input type="checkbox"/>	00057 (CIR INT W/ TO...	O00057.nc	398 B	08-07-2018 10:42
<input type="checkbox"/>	00067	O00067.nc	489 B	01-18-2018 10:34
<input type="checkbox"/>	00071	O00071.nc	600 B	01-18-2018 11:43
<input type="checkbox"/>	00074 (G71 TYPE II EX...	O00074.nc	602 B	08-07-2018 10:50
<input type="checkbox"/>	00101 (TM MANUAL)	O00101.nc	4 KB	02-14-2018 12:08
<input type="checkbox"/>	00123	O00123.nc	9 B	01-18-2018 14:23
<input type="checkbox"/>	00200 (BK1 X)	O0200.txt	507 B	04-04-2018 16:44
<input checked="" type="checkbox"/>	00555 (TL MANUAL)	O00555.nc	540 B	08-09-2018 14:06 *
<input type="checkbox"/>	00666	O00666.nc	166 B	04-18-2018 12:44
<input type="checkbox"/>	01000 (07463037)	O1000.TXT	365 B	04-04-2018 09:24
<input type="checkbox"/>	01111 (LATHE MAN)	O01111.nc	1018 B	08-08-2018 09:00

File Name: O00555.nc
 File comment: (TL MANUAL)
 Folder Has: 27 Items Disk Space: 906 MB Free (88%) Selected Items: 0

New [INSERT]
 Load [SELECT PROG]
 Edit [ALTER]
 Mark [ENTER]
 Copy [F2]
 File [F3]
 System [F4]

The program is then validated by running it in Graphics. Below the facing tool T101 rapids to outside the stock and faces off the part using just one pass.

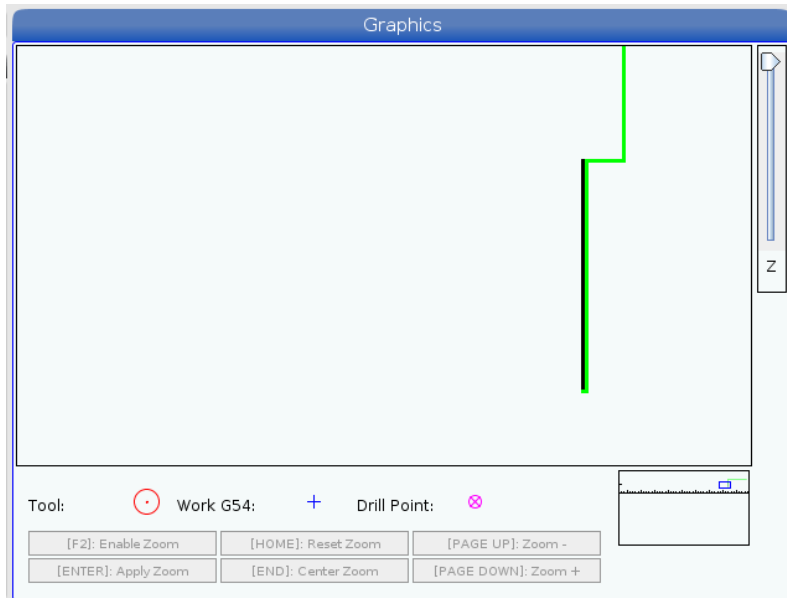

Then a turning operation is added by using the OD turn menu. The 2" stock is turned down to 1.5" Diameter 1.5" back from the face.

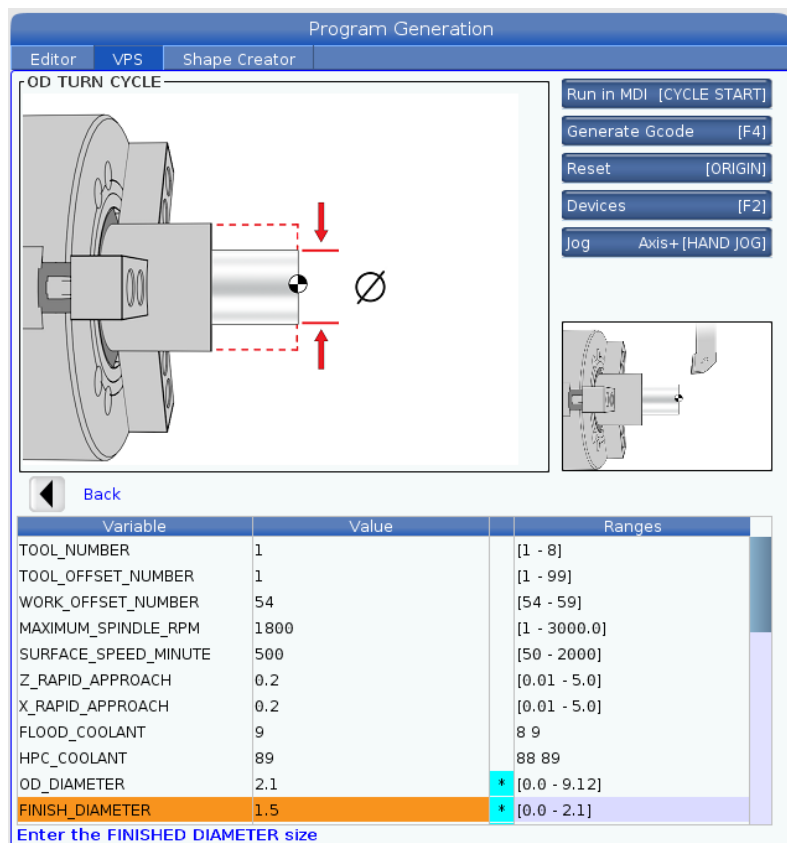

This time when the code is created we use 1 Insert to Clipboard.



Below the code is placed in the clipboard. At the end of the facing cycle the code is pasted from the clipboard by using F4 key. As shown at the bottom. Then the code needs to be saved by using the Memory key.

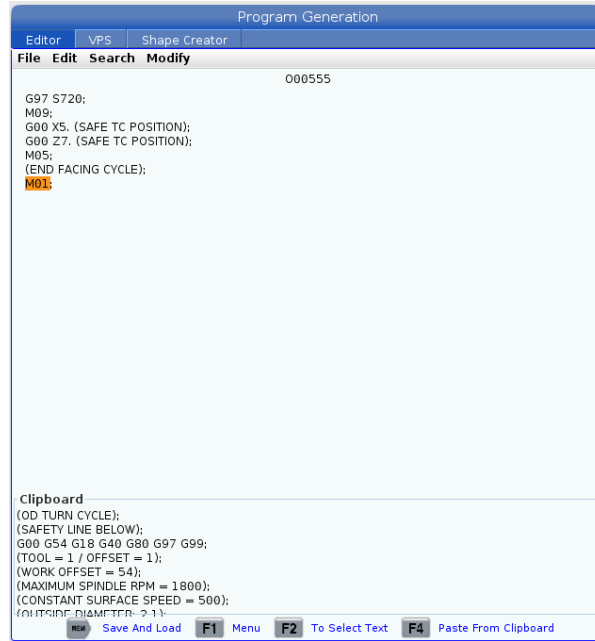

TL Series Training Part

In similar fashion a .1" chamfer was added to the end of the 1.5" diameter and a .10 radius added to the 2.0" diameter. Then a cut off tool was added to the program. Below is the graphics of the complete part.

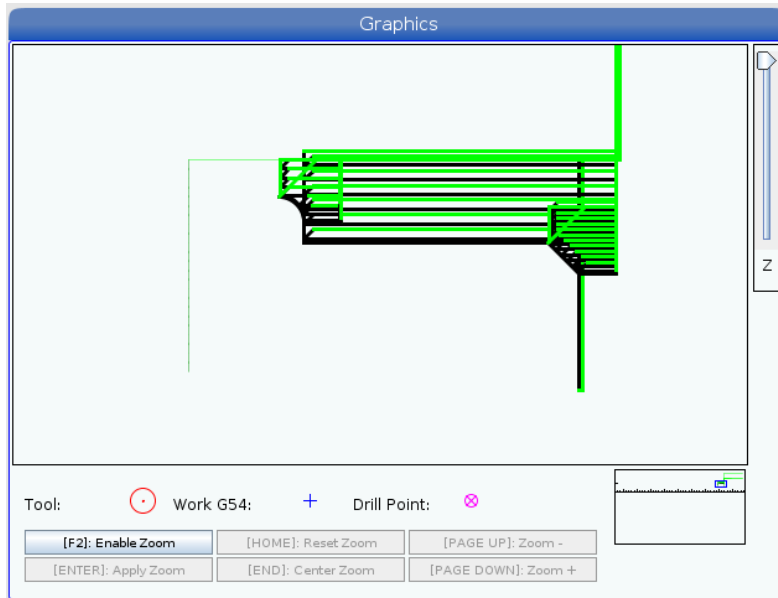

Below is the final code created using the VPS.

```
%  
O00555 (TL MANUAL)  
(FACING CYCLE)  
(SAFETY LINE BELOW)  
G00 G54 G18 G40 G80 G97 G99  
(TOOL = 1 / OFFSET = 1)  
(WORK OFFSET = 54)  
(MAXIMUM SPINDLE RPM = 1800)  
(CONSTANT SURFACE SPEED = 500)  
(OUTSIDE DIAMETER: 2.0)  
(FINISH DIAMETER: -0.1)  
(STOCK TO REMOVE = 0.02)  
(DEPTH PER PASS = .02)  
T101  
G54  
G50 S1800  
G97 S720 M03  
G00 Z0.22  
G00 X2.4  
M08  
G96 S500  
G00 Z0.02  
G72 P8662 Q8663 D0.02 U0. W0. F0.01  
N8662 G00 Z0.  
G01 X-0.1  
N8663 G00 Z0.02  
G00 G80 Z0.22  
G97 S720  
M09  
G00 X5. (SAFE TC POSITION)  
G00 Z7. (SAFE TC POSITION)  
M05  
(END FACING CYCLE)  
M01  
(OD TURN CYCLE)  
(SAFETY LINE BELOW)  
G00 G54 G18 G40 G80 G97 G99  
(TOOL = 1 / OFFSET = 1)  
(WORK OFFSET = 54)  
(MAXIMUM SPINDLE RPM = 1800)  
(CONSTANT SURFACE SPEED = 500)  
(OUTSIDE DIAMETER: 2.1)  
(FINISH DIAMETER: 1.5)  
(FILLET RADIUS = 0.0)  
(DEPTH PER PASS = .1)  
T101  
G54  
G50 S1800  
G97 S720 M03  
G00 Z0.2
```

G00 X2.5
M09
G96 S500
G71 P9331 Q9332 D0.08 U0.01 W0.003 F0.01
N9331 G00 X1.5
G01 Z-1.5
N9332 X2.5
G70 P9331 Q9332 F0.007
G00 Z0.2
G97 S720
M09
G00 X5. (SAFE TC POSITION)
G00 Z2. (SAFE TC POSITION)
M05
(END OD TURN CYCLE)
M01
(OD CHAMFER CYCLE)
(SAFETY LINE BELOW)
G00 G54 G18 G40 G80 G97 G99
(TOOL = 1 / OFFSET = 1)
(WORK OFFSET = 54)
(MAXIMUM SPINDLE RPM = 1800)
(CONSTANT SPEED SPEED = 500)
(CHAMFER LENGTH = .15 / CHAMFER ANGLE = 45.)
(DEPTH PER PASS = 0.03)
T101
G54
G50 S1800
G97 S720 M03
G00 Z0.2
G00 X1.9
M09
G96 S500
G71 P9684 Q9685 D0.03 U0.01 W0.003 F0.01
N9684 G00 X1.1634
G01 Z0.
N9685 G01 X1.5 Z-0.1683
G70 P9684 Q9685 F0.005
G00 X1.9
G00 Z0.2
M09
G97 S720
G00 X5.5
G00 Z3.
M05
(END OD CHAMFER CYCLE)
M01
(OD RADIUS CYCLE)
(SAFETY LINE BELOW)
G00 G54 G18 G40 G80 G97 G99
(TOOL = 1 / OFFSET = 1)
(WORK OFFSET = 54)
(MAXIMUM SPINDLE RPM = 1800)
(CONSTANT SURFACE SPEED = 500)

```

(OUTSIDE DIAMETER = 2.0)
(RADIUS DIMENSION = .1)
(TOOL TIP RADIUS = .0312)
T101
G54
G50 S1800
G97 S720 M03
G00 Z0.2
G00 X2.4
M09
G00 Z-1.3
G96 S500
G96 S500
Q9718 F0.005
G00 X2.4
G00 Z0.2 G80
G97 S720
M09
G00 X8.9
G00 Z7.
M05
(END OD RADIUS CYCLE)
M01
(OD Part Off)
(SAFETY LINE BELOW)
G00 G54 G18 G40 G80 G97 G99
(TOOL = 2 / OFFSET = 2)
(WORK OFFSET = 54)
(SPINDLE RPM = 500)
(INSERT WIDTH = .125)
(SETTING 22 CHIP BREAK RETRACT = 0.01)
T202
G54
G50 S500
G97 S500 M03
G00 Z0.2
M37 (PARTS CATCHER)
G00 X2.4
M08
G00 Z-2.125
G75 I0.05 X0.1 F0.003
G00 X2.4
G00 Z0.2
M09
G00 X5. (SAFE TC POSITION)
G00 Z7. (SAFE TC POSITION)
M37 (PARTS CATHER DOWN)
M05
(END OD PART OFF CYCLE)
M01
%
```

